

# Panasonic®

## Operating Instructions

### Memory Card Camera-Recorder

Before use

Description of parts

Preparation

Shooting

Playback

Editing

Displays

Menu

Reference



Mini DV NTSC

Model No. AG-**HVX200**P

**DVCPRO HD**

**DVCPRO 50**

**DVCPRO**

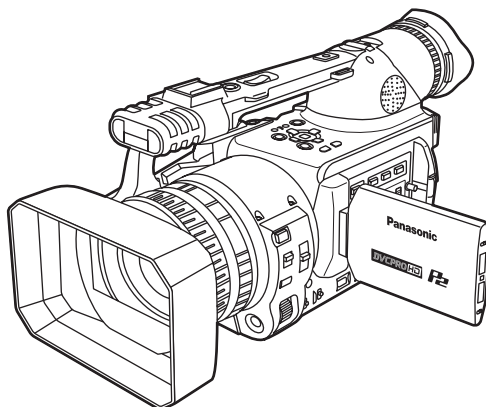

Before operating this product, please read the instructions carefully and save this manual for future use.



**CAUTION**  
**RISK OF ELECTRIC SHOCK**  
**DO NOT OPEN**



**CAUTION:** TO REDUCE THE RISK OF ELECTRIC SHOCK, DO NOT REMOVE COVER (OR BACK). NO USER-SERVICEABLE PARTS INSIDE. REFER TO SERVICING TO QUALIFIED SERVICE PERSONNEL.



The lightning flash with arrowhead symbol, within an equilateral triangle, is intended to alert the user to the presence of uninsulated "dangerous voltage" within the product's enclosure that may be of sufficient magnitude to constitute a risk of electric shock to persons.



The exclamation point within an equilateral triangle is intended to alert the user to the presence of important operating and maintenance (servicing) instructions in the literature accompanying the appliance.

**WARNING:**

- TO REDUCE THE RISK OF FIRE OR SHOCK HAZARD, DO NOT EXPOSE THIS EQUIPMENT TO RAIN OR MOISTURE.
- TO REDUCE THE RISK OF FIRE OR SHOCK HAZARD, KEEP THIS EQUIPMENT AWAY FROM ALL LIQUIDS. USE AND STORE ONLY IN LOCATIONS WHICH ARE NOT EXPOSED TO THE RISK OF DRIPPING OR SPLASHING LIQUIDS, AND DO NOT PLACE ANY LIQUID CONTAINERS ON TOP OF THE EQUIPMENT.

**CAUTION:**

TO REDUCE THE RISK OF FIRE OR SHOCK HAZARD AND ANNOYING INTERFERENCE, USE THE RECOMMENDED ACCESSORIES ONLY.

**CAUTION:**

THE AC RECEPTACLE (MAINS SOCKET OUTLET) SHALL BE INSTALLED NEAR THE EQUIPMENT AND SHALL BE EASILY ACCESSIBLE.

TO COMPLETELY DISCONNECT THIS EQUIPMENT FROM THE AC MAINS, DISCONNECT THE POWER CORD PLUG FROM THE AC RECEPTACLE.

**CAUTION:**

Danger of explosion or fire if battery is mistreated.

- Replace only with same or specified type.
- Do not disassemble or dispose of in fire.
- Do not store in temperatures over 140°F (60°C).
- Use specified charger for rechargeable batteries.
- Do not recharge the battery if it is not a rechargeable type.

**For Remote Controller**

- Replace battery with part No. CR2025 only.
- Do not recharge the battery.

**Camera-Recorder**

The rating plate is on the underside of the Camera-Recorder

**AC Adapter**

The rating plate is on the underside of the AC Adapter.

Disconnect the AC mains plug from the AC mains socket when not in use.

**CAUTION:**

In order to maintain adequate ventilation, do not install or place this unit in a bookcase, built-in cabinet or any other confined space. To prevent risk of electric shock or fire hazard due to overheating, ensure that curtains and any other materials do not obstruct the ventilation.

 indicates safety information.

**IMPORTANT**

"Unauthorized recording of copyrighted television programs, video tapes and other materials may infringe the right of copyright owners and be contrary to copyright laws."

## FCC NOTICE (USA)

### Declaration of Conformity

Model Number: AG-HVX200P

Trade Name: PANASONIC

Responsible Party: Panasonic Corporation of North America One Panasonic Way, Secaucus, NJ  
07094

Support contact: Panasonic Broadcast & Television Systems Company 1-800-524-1448

This device complies with Part 15 of FCC Rules.

Operation is subject to the following two conditions:

(1) This device may not cause harmful interference, and (2) this device must accept any interference received, including interference that may cause undesired operation.

To assure continued compliance, follow the attached installation instructions and do not make any unauthorized modifications.

### CAUTION:

This equipment has been tested and found to comply with the limits for a Class B digital device, pursuant to Part 15 of the FCC Rules. These limits are designed to provide reasonable protection against harmful interference in a residential installation. This equipment generates, uses and can radiate radio frequency energy and, if not installed and used in accordance with the instructions, may cause harmful interference to radio communications. However, there is no guarantee that interference will not occur in a particular installation. If this equipment does cause harmful interference to radio or television reception, which can be determined by turning the equipment off and on, the user is encouraged to try to correct the interference by one of the following measures:

- Reorient or relocate the receiving antenna.
- Increase the separation between the equipment and receiver.
- Connect the equipment into an outlet on a circuit different from that to which the receiver is connected.
- Consult the dealer or an experienced radio/TV technician for help.

The user may find the booklet "Something About Interference" available from FCC local regional offices helpful.

### FCC Warning:

To assure continued FCC emission limit compliance, the user must use only shielded interface cables when connecting to host computer or peripheral devices. Also, any unauthorized changes or modifications to this equipment could void the user's authority to operate this device.

## NOTIFICATION (Canada)

This class B digital apparatus complies with Canadian ICES-003.

Cet appareil numérique de la classe B est conforme à la norme NMB-003 du Canada.

 indicates safety information.

## Software information for this product

1. Customer advisory: This product includes software licensed under the GNU General Public License (GPL) and GNU Lesser General Public License (LGPL); customers have the right to download, modify, and redistribute source code for this software.  
Descriptions of the GPL and LGPL are stored on the installation CD included with this camera-recorder. See the folder named \LDOC. (The description is the original (written in English)). To download the relevant source code, visit <https://www.pavc.panasonic.co.jp/pro-av/>  
Please note that we cannot answer any questions you may have about the content, etc. of any source code you may obtain from the above Web site.
2. This product includes software licensed under the MIT License. A description of the MIT is stored on the installation CD included with this camera-recorder. See the folder named \LDOC. (The description is the original (written in English)).

- LEICA is a trademark of Leica Microsystems IRGmbH.
- DICOMAR is a trademark of Leica Camera AG.
- SD logo is a trademark. 

All other explanations, company names, and product names are the registered trademarks of the respective companies.

# IMPORTANT SAFETY INSTRUCTIONS

- 1) Read these instructions.
- 2) Keep these instructions.
- 3) Heed all warnings.
- 4) Follow all instructions.
- 5) Do not use this apparatus near water.
- 6) Clean only with dry cloth.
- 7) Do not block any ventilation openings. Install in accordance with the manufacturer's instructions.
- 8) Do not install near any heat sources such as radiators, heat registers, stoves, or other apparatus (including amplifiers) that produce heat.
- 9) Do not defeat the safety purpose of the polarized or grounding-type plug. A polarized plug has two blades with one wider than the other. A grounding-type plug has two blades and a third grounding prong. The wide blade or the third prong are provided for your safety. If the provided plug does not fit into your outlet, consult an electrician for replacement of the obsolete outlet.
- 10) Protect the power cord from being walked on or pinched particularly at plugs, convenience receptacles, and the point where they exit from the apparatus.
- 11) Only use attachments/accessories specified by the manufacturer.
- 12) Use only with the cart, stand, tripod, bracket, or table specified by the manufacturer, or sold with the apparatus. When a cart is used, use caution when moving the cart/apparatus combination to avoid injury from tip-over.
- 13) Unplug this apparatus during lightning storms or when unused for long periods of time.
- 14) Refer all servicing to qualified service personnel. Servicing is required when the apparatus has been damaged in any way, such as power-supply cord or plug is damaged, liquid has been spilled or objects have fallen into the apparatus, the apparatus has been exposed to rain or moisture, does not operate normally, or has been dropped.



# Contents

## Before use

Software information for this product .....	4
<b>IMPORTANT SAFETY INSTRUCTIONS</b> .....	<b>5</b>
<b>Outline of operations</b> .....	<b>8</b>
<b>Read this first!</b> .....	<b>10</b>
<b>Accessories</b> .....	<b>11</b>
<b>About this manual</b> .....	<b>11</b>

## Description of parts

<b>Description of parts</b> .....	<b>12</b>
Right side and rear side .....	12
Left side .....	13
Terminals and mounting parts .....	14
Remote control .....	15

## Preparation

<b>The battery</b> .....	<b>16</b>
Charging .....	16
<b>Installing and removing the power supply</b> .....	<b>17</b>
Installing and removing the battery .....	17
Connecting and disconnecting the power cord ...	17
<b>Adjusting the hand strap</b> .....	<b>18</b>
<b>Attaching the shoulder strap</b> .....	<b>18</b>
<b>Detaching and attaching the lens hood</b> .....	<b>18</b>
<b>The remote control</b> .....	<b>19</b>
Insert the battery .....	19
Remote control setup .....	19
<b>Turn on/off the camera</b> .....	<b>20</b>
<b>Tally lamp</b> .....	<b>20</b>
<b>Viewfinder</b> .....	<b>21</b>
Using the viewfinder .....	21
Using the LCD .....	22
Emphasizing outlines .....	22
Adjusting the screen display .....	23
<b>Setting the calendar</b> .....	<b>24</b>

## Shooting

<b>Basic shooting operations (P2 card)</b> .....	<b>25</b>
Preparing to shoot using a P2 card .....	25
Shooting in auto mode .....	25
Checking photos taken (REC CHECK) .....	26
P2 card access lamps .....	26
Protecting against a possible erasure .....	26
Formatting P2 cards .....	27
Recording times .....	27
Remove the P2 card .....	28
<b>Basic shooting operations (Cassette tape)</b> .....	<b>29</b>
Preparing to shoot using a tape .....	29
Shooting in auto mode .....	29
Checking scenes taken (REC CHECK) .....	30

Remove the cassette tape .....	30
Cassette tapes .....	31
<b>Using SD memory cards</b> .....	<b>32</b>
Installing and removing the SD memory card ..	32
Formatting SD memory card .....	32
Cautions in using SD memory cards .....	32
<b>Using the zoom function</b> .....	<b>33</b>
<b>Variable frame rates (VFR)</b> .....	<b>34</b>
Native recording .....	35
Standard recording .....	35
Using variable frame rates (VFR) .....	36
<b>Shooting in 1080i/480i progressive mode</b> ..	<b>37</b>
<b>Shooting in manual mode</b> .....	<b>38</b>
Switching to manual mode .....	38
Manual focusing .....	38
Using focus assist .....	38
Iris adjustments .....	39
Adjusting the gain .....	39
Light intensity adjustments .....	39
Adjusting the white balance .....	40
<b>Shooting techniques for different targets</b> ..	<b>42</b>
Low-angle shooting .....	42
Self-portrait shooting .....	42
Zebra pattern .....	43
Marker .....	43
Checking and displaying shooting status .....	44
Changing the image size .....	44
Optical Image Stabilizer .....	45
Adding effects to images .....	45
Using the USER buttons .....	45
Backlight compensation .....	45
Color bars .....	45
Adjusting the volume while shooting .....	46
Backup recording .....	46
Pre-recording (PRE REC) .....	47
Interval recording (INTERVAL REC) .....	47
One-shot recording (ONE-SHOT REC) .....	47
Loop recording (LOOP REC) .....	48
2-slot continuous recording .....	48
Shot mark function .....	48
Text memo recording .....	48
Finding specific scenes (image search) .....	49
Index recording .....	49
<b>Adjusting the shutter speed</b> .....	<b>50</b>
Synchro scan .....	51
<b>Switching Audio Input</b> .....	<b>52</b>
Using the built-in microphone .....	52
Using another microphone and audio equipment .....	52
Adjusting the recording level .....	53
<b>Using scene files</b> .....	<b>54</b>
Changing scene file settings .....	54
<b>Saving scene files and other settings on SD memory cards</b> .....	<b>56</b>
<b>Clip metadata</b> .....	<b>57</b>

<b>Using the Counter</b> .....	<b>58</b>
Counter display (P2 card / Tape) .....	58
Memory stop mode (Tape) .....	58
1394TC preset mode .....	58
<b>Charging the built-in battery/ Setting the time data</b> .....	<b>59</b>
Recharging the built-in battery .....	59
Setting the time code .....	59
Specifying the time code (TC PRESET) .....	59
Setting user information .....	60

## Playback

<b>Basic playback operations (P2 card)</b> .....	<b>62</b>
<b>Basic playback operations (Tape)</b> .....	<b>63</b>
<b>Thumbnail screen</b> .....	<b>64</b>
Basic thumbnail screen operations .....	64
Adding shot marks to clips .....	66
Clearing the thumbnail screen .....	66
Direct shooting functions .....	66
<b>Thumbnail operations</b> .....	<b>67</b>
Selecting the thumbnail display method (THUMBNAIL) .....	67
Deleting clips and formatting cards (OPERATION) .....	69
Checking the clip or card information (PROPERTY) .....	70
Uploading the metadata (META DATA) .....	72
<b>Useful playback functions</b> .....	<b>73</b>
Variable speed search (P2 card / Tape) .....	73
Slow playback (P2 card / Tape) .....	73
Fast forward/rewind playback (P2 card) .....	73
Fast forward/rewind playback (Tape) .....	73
Frame-by-frame playback (P2 card / Tape) .....	74
Clip skip (P2 card) .....	74
End search (Tape) .....	74
Index search (Tape) .....	75
Adjusting the volume (P2 card / Tape) .....	75
Viewing images on a television (P2 card / Tape) .....	75
Checking the date and time (P2 card / Tape) ..	75

## Editing

<b>Connecting external units</b> .....	<b>76</b>
Headphones .....	76
External microphone .....	76
Computer (non-linear editing/file transfer) .....	77
Hard disk drive (data copying) .....	77
Digital video equipment (Dubbing) .....	78
Video deck (Dubbing) .....	79
TV/Monitor (playback/dubbing) .....	79
<b>Audio dubbing</b> .....	<b>80</b>
<b>Nonlinear editing with P2 card (PC mode)</b> .....	<b>82</b>

<b>Copying from P2 cards to the hard disk drive (1394 HOST mode)</b> .....	<b>84</b>
Warnings .....	85
<b>Dubbing</b> .....	<b>86</b>
Dubbing the contents of P2 cards onto a tape (dubbing mode) .....	86
Digital input/output (P2 card/Tape) .....	87
Analog output (P2 card/Tape) .....	88
Analog input (Tape) .....	89

## Displays

<b>Screen displays</b> .....	<b>90</b>
Regular displays .....	90
Warnings .....	93
Setting the DISPLAY items .....	95

## Menus

<b>Using the setup menus</b> .....	<b>96</b>
Using the menus .....	96
Initializing the menu settings .....	97
<b>Setup menu structure</b> .....	<b>98</b>
Camera mode menu .....	98
MCR/VCR (playback) mode menu .....	99
Dubbing mode menu .....	99
<b>Setup menu list</b> .....	<b>100</b>
SCENE FILE screen .....	100
CAMERA SETUP screen .....	102
SW MODE screen .....	103
AUTO SW screen .....	105
RECORDING SETUP screen .....	106
PLAYBACK FUNCTIONS screen .....	109
DUBBING SETUP screen .....	111
AV IN/OUT SETUP screen .....	111
DISPLAY SETUP screen .....	112
CARD FUNCTIONS screen .....	114
OTHER FUNCTIONS screen .....	114
OPTION MENU .....	118

## Reference

<b>Before calling for service</b> .....	<b>119</b>
<b>Operating precautions</b> .....	<b>123</b>
<b>Updating the driver in the camera</b> .....	<b>125</b>
<b>Condensation</b> .....	<b>125</b>
<b>System resetting</b> .....	<b>126</b>
<b>Cleaning</b> .....	<b>126</b>
<b>Video Heads</b> .....	<b>127</b>
<b>Storage Precautions</b> .....	<b>128</b>
<b>Recording format</b> .....	<b>129</b>
<b>Specifications</b> .....	<b>130</b>

# Outline of operations

This unit is compatible with P2 (Professional Plug-in) cards or DV cassette tapes.

The P2 card has a large capacity with a high transfer rate, and allows you sophisticated movie-making on this handy camera, including HD (High Definition) recording and smooth editing/dubbing.

## Flow of shooting, playing and saving

The setting values such as the user file are saved to and read from the SD memory card.

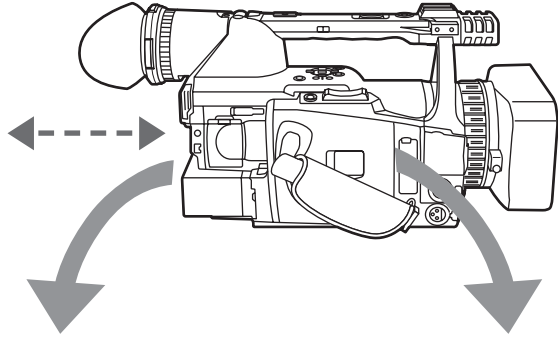

### 1 P2 mode shooting and playback (Pages 25 and 73)

#### P2 card



You can use the following features:

- HD (High Definition) recording
- Multi format recording
- Variable frame rates
- Slow & quick motion recording
- Maximum 4 channel uncompressed digital audio recording
- DV recording (480i)

### 2 Cassette tape shooting and playback (Pages 29 and 73)

#### DV cassette tape

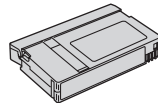

- DV recording (480i)
- Dubbing mode recording from a P2 card is possible.

### 3 Dubbing mode (Page 86)

**Dubbing mode is a function for down-converting contents recorded in HD (1080i, 720P) on the P2 card to an DV format (480i) and recording it to tape. You can record onto DV tape contents that have a slow & quick motion effect.**

**This is useful when backing up images and checking images on AV equipment.**

- You cannot simultaneously shoot on both the P2 card and the DV cassette tape.
- High-definition (HD) recording to a DV tape is not possible.



**Saving and editing on external devices**

**4 PC mode (Page 82)**

The data (file) is transferred for nonlinear editing on your computer or other unit.

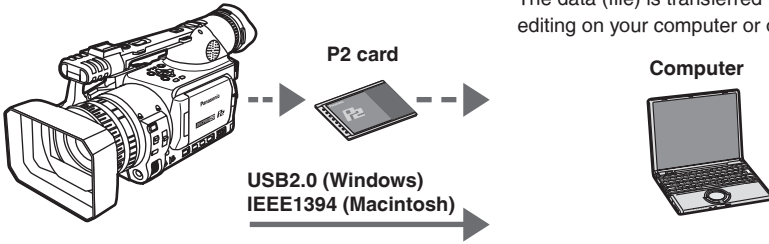

**5 1394 host mode (Page 84)**

The unit directly controls the external hard disk drive, and transfers the data (file) to it.

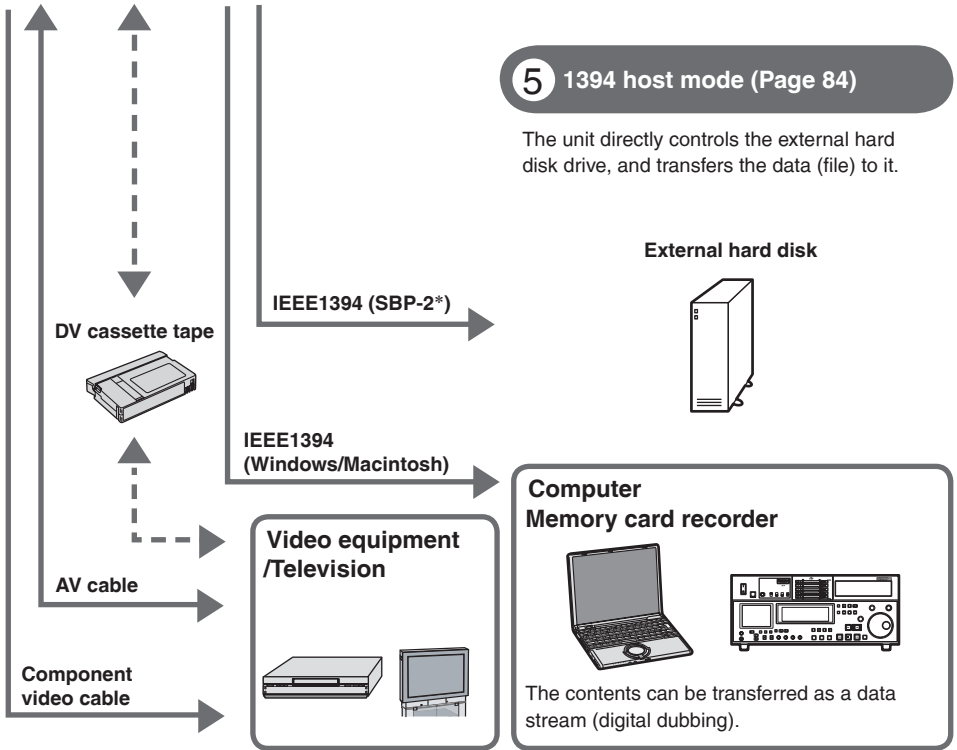

\*Serial Bus Protocol-2

# Read this first!

---

## **Always take some trial shots before actual shooting.**

- When shooting important events (such as weddings), always take some trial shots and check that the sound and images have been recorded properly before actual shooting.

## **Be sure to check and set the calendar and time zone.**

- These settings affect the control and playback sequence of the recorded contents. Before making a recording, set and check the calendar and time zone. (Page 24)

## **Panasonic makes no guarantees for your recordings.**

- Please understand that Panasonic makes no guarantees for your recordings in cases where images and/or sound were not recorded as you intended due to problems with the camera-recorder or cassette.

## **Respect copyrights**

- Copyright laws forbid the use of video and audio material you have recorded for any purpose other than your own personal enjoyment. Remember that restrictions apply to the shooting of certain material even if it is intended for private use.

## **Caution regarding laser beams**

- The CCD may be damaged if it is subjected to light from a laser beam.  
When using the camera-recorder in locations where laser irradiation equipment is used, be careful not to allow the laser beam to shine directly on the lens.

## **Notes when connecting a DV (IEEE1394) cable**

- Windows:  
Before connecting, turn off the main unit power, and check the shape and orientation of the terminal.
- Macintosh:  
After turning on the power of the Apple Macintosh computer, check the shape and orientation of the terminal, and then connect the cable.

(Pages 77, 78)

## **Media that can be used in this unit**

The following media can be used in this unit. For details, refer to the respective pages.

- P2 card (Page 27)
- Digital video cassette tape (Page 30)
- SD memory card (Page 32)

## **Mounting the camera-recorder on a tripod**

The tripod mounting hole is 5.5 mm deep. Do not force the tripod screw beyond this depth.

You can damage the camera-recorder if you use any screw other than 1/4-20UNC.



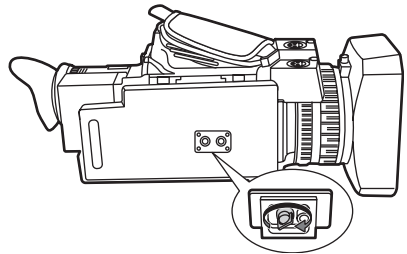





For other usage notes, see page 123.

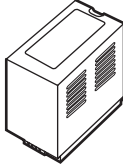
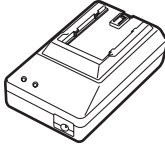
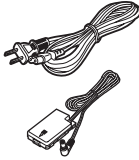

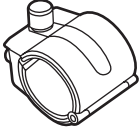
**Attach the tripod to the tripod hole**

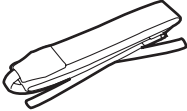
# Accessories

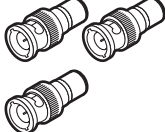
Before use

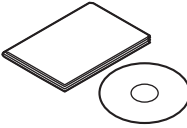
<p><b>Battery</b> *1</p> 	<p><b>AC Adapter</b></p> 	<p><b>AC power supply cord /DC cord</b></p> 	<p><b>Wireless remote control and button battery (CR2025)</b></p> 
<p><b>Eye cup</b></p> 	<p><b>Microphone holder</b></p> 	<p><b>6-mm screws (2)</b> <b>12-mm screws (2)</b></p> 	<p><b>Microphone holder adapter</b></p> 
<p><b>Shoulder belt</b></p> 	<p><b>Component video cable</b></p> 	<p><b>PIN-BNC conversion cable (3)</b></p> 	<p><b>Ferrite core</b> *2</p> 
<p><b>Documents and CDs</b></p> 	<p>A lens hood cap (page 18) and INPUT 1/2 terminal (page 14) cover are attached to the camera-recorder.</p>		

\*1 For part numbers for the battery, see "OPTIONAL UNITS". (Page 132)

\*2 When using 1394 cable (sold separately), install a ferrite core on the end nearest the PC. (Page 78)

## About this manual

### Note concerning illustrations in these instructions

- Illustrations (camera-recorder, menu screens, etc.) in these operating instructions differ slightly from the actual camera-recorder.

### References

- References are shown as (Page 10).

### Icons

Explanations specific to the media used are identified by the icons below.

**P2** : Explanations for P2 card usage only.

**TAPE** : Explanations for tape usage only.

# Description of parts

## Right side and rear side

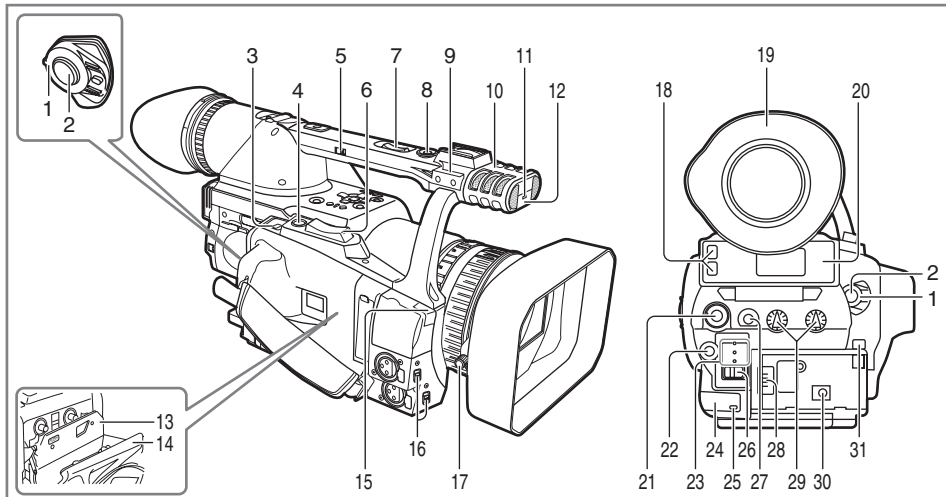

- 1 POWER switch (Page 20)
- 2 START/STOP button (Pages 25 and 29)
- 3 OPEN/EJECT switch (Page 29)
- 4 REC CHECK button (Pages 25 and 30)
- 5 HANDLE ZOOM switch (Page 33)
- 6 Zoom button (Page 33)
- 7 Handle zoom button (Page 33)
- 8 Handle START/STOP button (Pages 25 and 29)
- 9 Pin hole (for zoom ring) (Page 13)
- 10 Built-in stereo microphone (Page 52)
- 11 Tally lamp (Front) (Page 20)
- 12 Remote control sensor (Front)
- 13 Cassette holder (Pages 29 and 30)
- 14 Cassette cover (Pages 29 and 30)
- 15 White balance sensor (Page 40)
- 16 INPUT 1/2 (audio input) switch (Page 52)
- 17 Lens hood screw (Page 18)
- 18 P2 card access lamp (x 2) (Page 26)
- 19 Viewfinder (Page 21)
- 20 P2 card slot (x 2) (Page 25)
- 21 SCENE FILE dial (Page 54)
- 22 Mode button (Page 25 and 29)
- 23 Mode lamp (Page 25 and 29)
- 24 Remote control sensor (Rear)
- 25 Tally lamp (Rear) (Page 20)
- 26 MEDIA (P2/TAPE) switch (Pages 25 and 29)
- 27 EVF DTL button (Page 22)
- 28 Power terminal (Page 17)
- 29 AUDIO control (Page 53)
- 30 DC INPUT terminal (7.9 V)
- 31 Battery release button (Page 17)

## Left side

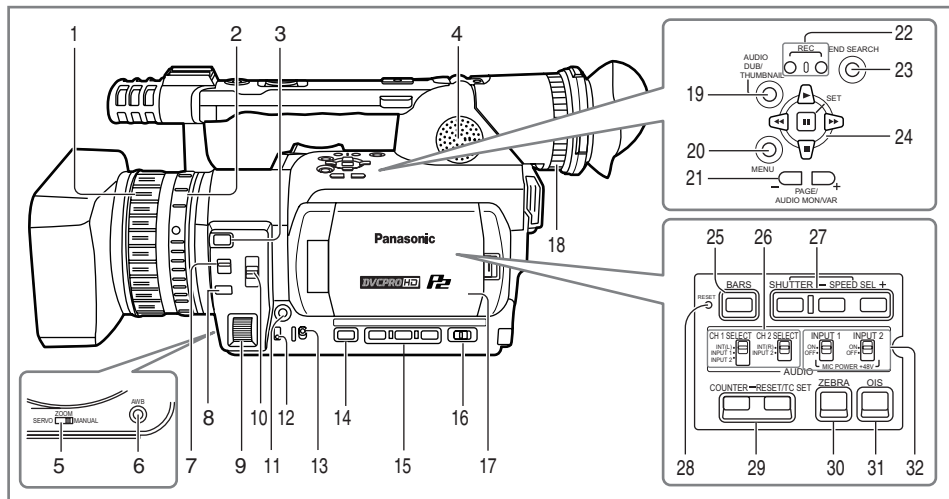

- |  |   |
|--|---|
| <p><b>1 Focus ring (Page 38)</b></p> <p><b>2 Zoom ring (Page 33)</b><br/>If you don't need the zoom ring pin, fit it into the provided pin hole (Page 12) so that you don't lose it.</p> <p><b>3 FOCUS ASSIST button (Page 38)</b></p> <p><b>4 Built-in speaker (Page 75)</b></p> <p><b>5 ZOOM switch (Page 33)</b></p> <p><b>6 AWB button (Page 40)</b></p> <p><b>7 FOCUS switch (Page 38)</b></p> <p><b>8 PUSH AUTO button (Page 38)</b></p> <p><b>9 IRIS dial (Page 39)</b></p> <p><b>10 ND FILTER switch (Page 39)</b></p> <p><b>11 IRIS button (Page 39)</b></p> <p><b>12 GAIN switch (Page 39)</b></p> <p><b>13 WHITE BAL switch (Page 40)</b></p> <p><b>14 DISP/MODE CHK button (Page 44)</b></p> <p><b>15 USER button (Page 45)</b></p> <p><b>16 AUTO/MANUAL switch (Pages 25 and 29)</b></p> <p><b>17 LCD monitor (Page 22)</b></p> <p><b>18 Diopter adjustment dial (Page 21)</b></p> <p><b>19 AUDIO DUB/THUMBNAIL button (Pages 65 and 80)</b></p> <p><b>20 MENU button (Page 96)</b></p> | <p><b>21 PAGE, AUDIO MON/VAR button (Pages 46 and 73)</b></p> <p><b>22 REC button (Page 87)</b></p> <p><b>23 END SEARCH button (Page 74)</b></p> <p><b>24 Operation button (Page 96)</b></p> <p><b>25 BARS button (Page 45)</b></p> <p><b>26 CH1, CH2 SELECT switch (Page 52)</b></p> <p><b>27 SHUTTER - SPEED SEL button (Page 50)</b></p> <p><b>28 RESET button (Page 126)</b></p> <p><b>29 COUNTER - RESET/TC SET button (Page 58)</b></p> <p><b>30 ZEBRA button (Page 43)</b></p> <p><b>31 OIS button (Page 45)</b></p> <p><b>32 INPUT1, 2 switch (MIC POWER +48 V) (Page 52)</b></p> |
|--|---|

## Description of parts (continued)

### Terminals and mounting parts

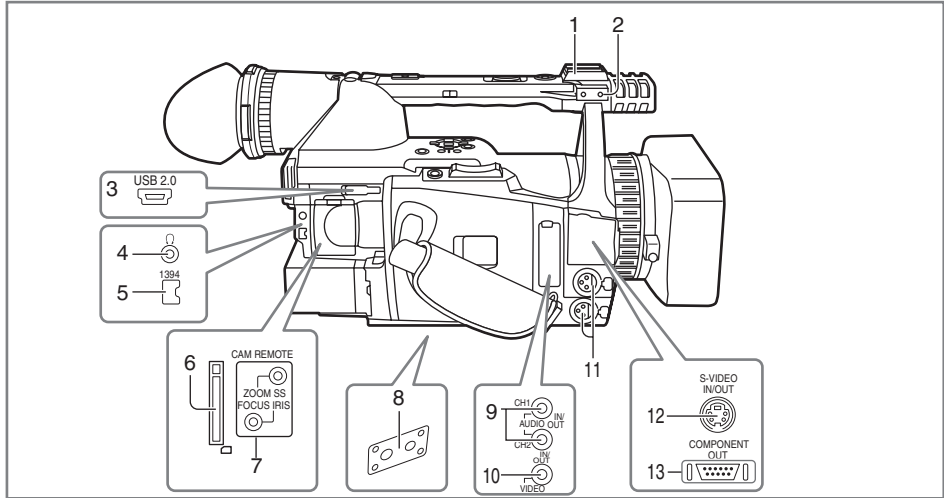

- 1 **Light shoe**
- 2 **Microphone shoe (Page 76)**
- 3 **USB terminal (Mini-B) (Pages 77 and 82)**
- 4 **PHONES jack (3.5 mm stereo mini jack) (Page 76)**
- 5 **1394 terminal (Page 77)**
- 6 **SD memory card slot (Pages 32 and 56)**
- 7 **CAM REMOTE jack\***
  - FOCUS/IRIS** (3.5 mm mini jack)  
You can connect a remote control unit to control the FOCUS and IRIS (aperture).
  - ZOOM S/S** (2.5 mm super mini jack)  
You can connect a remote control unit to control zoom and start/stop of recording.
- 8 **Tripod hole (Page 10)**
- 9 **AUDIO IN/OUT CH1/CH2 terminal (Page 79)**
- 10 **VIDEO IN/OUT terminal (Page 79)**
- 11 **INPUT 1/2 terminal (XLR, 3 pin) (Pages 52 and 80)**
- 12 **S-VIDEO IN/OUT terminal (Page 79)**
- 13 **COMPONENT OUTPUT terminal (Page 79)**

\* Do not connect any equipment except the remote controller to the remote control jack. If any equipment except the remote controller is connected, the pictures will be affected e.g. appear bright or out of focus.

## Remote control

The following buttons are for functions that cannot be executed on the camera-recorder.

- PHOTO SHOT
- MULTI/P-IN-P
- STORE
- PB. ZOOM
- TITLE
- SELECT
- OFF/ON

- 1 **DATE/TIME button (Page 75)**
- 2 **OSD button (Page 75)**
- 3 **COUNTER button (Page 58)**  
Same function as the COUNTER button on the main unit.
- 4 **COUNTER RESET button (Page 58)**  
Same function as the COUNTER RESET button on the main unit.
- 5 **A.DUB button (Page 80)**  
Same function as the AUDIO DUB button on the main unit.
- 6 **REC button (Page 87)**

Description of parts

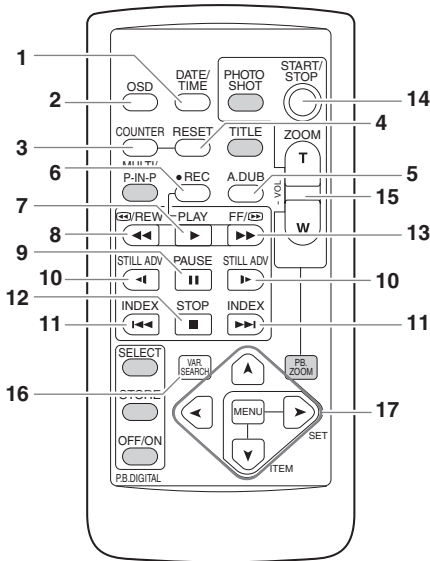

### Used during VCR mode

- 7 **PLAY button (▶) (Page 62)**
- 8 **◀/REW button (◀◀) (Page 62)**
- 9 **PAUSE button (||) (Page 62)**  
Like the operation buttons of the camera, MENU operations are performed using SET button.
- 10 **STILL ADV button (◀|, |▶) (Page 73)**
- 11 **INDEX buttons (◀◀, ▶▶) (Page 75)**
- 12 **STOP button (■) (Page 62)**
- 13 **FF/▶ button (▶▶) (Page 62)**

### Buttons for shooting and volume control

- 14 **START/STOP button**  
Same function as the START/STOP button on the main unit.
  - 15 **ZOOM/VOL buttons (Pages 33 and 75)**
  - 16 **VAR. SEARCH button (Page 73)**
  - 17 **MENU button**  
Functions the same as the MENU button on the camera.
- [◀], [▶], [▲], [▼] buttons**  
Function the same as the ◀, ▶, ▲, ▼ buttons on the camera.

# The battery

## Charging

Before using the battery, fully charge it with the AC adapter.

Keep a spare battery with you.

**1 Align the battery with the “≡” marking on the AC adapter, place it flat, and slide it in the direction shown below.**

- You cannot charge the battery if the DC OUT connector is connected to the DC OUT connector, so disconnect it first.

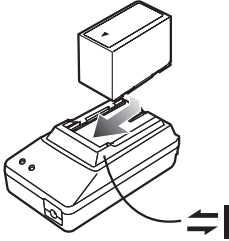

**2 Plug the AC cord into the power outlet.**

- The POWER lamp and CHARGE lamp on the AC adapter light, and charging begins.
- If the CHARGE lamp does not light when attached, detach the battery and then attach it again.

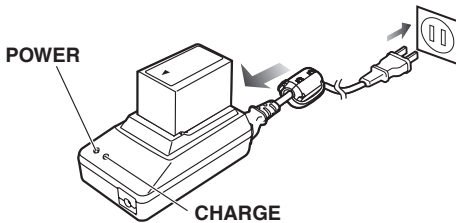

**3 When the battery is charged, the CHARGE lamp on the AC adapter goes out.**

**4 Slide the battery and remove it.**

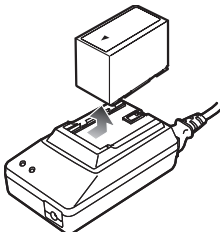

## Recording time of included battery

Recharging time	Continuous recording time
Approx. 330 min.	Approx. 140 min.

- The times given above are approximate for when scenes are shot in the DVCPRO HD mode on a P2 card while using the viewfinder.
- The times apply when the ambient operating temperature is 68°F (20°C) and humidity is 60%. Charging may take longer at other temperatures and humidity levels.

**• Keep metal objects (such as necklaces and hairpins) away from the battery. Short-circuiting may occur across the terminals, causing the battery to heat up, and you may seriously burn yourself if you touch the battery in this state.**

- The battery becomes hot while it is being used or charged. The camera-recorder itself also becomes hot during use.
- The recordable time reduces if you repeatedly start and stop recording.
- Discharge the battery before storing it. When storing it for an extended time, charge it at least once a year, use up its charge in the camera-recorder, and then store it again.
- If the battery is extremely hot or cold, the CHARGE lamp will blink several times before charging starts.
- If the CHARGE lamp continues to blink even when the battery temperature is normal, there may be something wrong with the battery or AC adapter. Contact your dealer.
- The battery takes longer to charge when it is warm.
- The AC adapter can interfere with radio reception so keep radios at least 1 meter away from it.
- The AC adapter may make some noise when you are using it, but this is normal.
- You cannot charge the battery when supplying power to the camera-recorder from the AC adapter.
- Operation of battery pack CGR-D16 (1600mAh) (sold separately) is not guaranteed.



# Installing and removing the power supply

## Installing and removing the battery

### Installation

Insert the battery until it clicks into place.

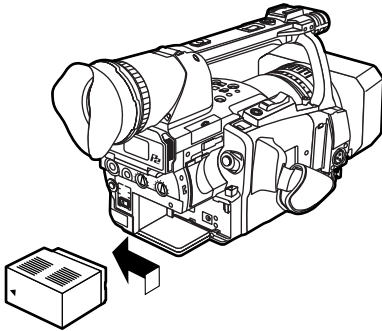

### Removal

- 1 Set the **POWER** switch to **OFF**, and check that the **mode lamp** is off.
- 2 Remove the battery while pressing the **battery release button**.
  - Support the battery with your hand to ensure that it will not fall.

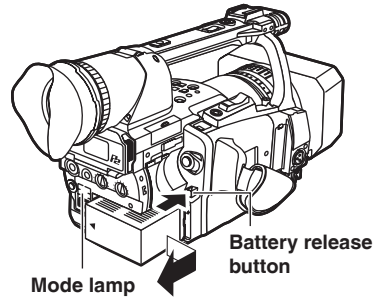

Preparation

## Connecting and disconnecting the power cord

### Installation

- 1 Connect the **DC cord** to the **AC adapter**.
- 2 Plug the **AC power supply** into the power outlet.
- 3 Insert the **DC cord's battery connector** until it clicks into place.

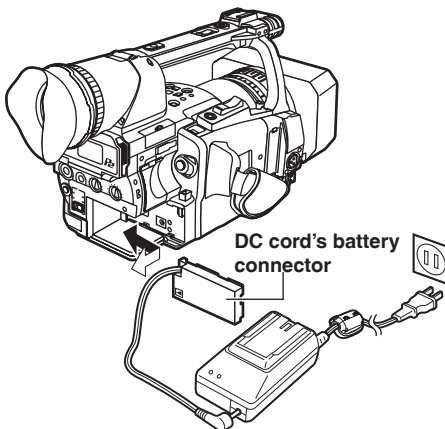

### Removal

- 1 Set the **POWER** switch to **OFF**, and check that the **mode lamp** is off.
- 2 Remove the **DC cord's battery connector** while pressing the **battery release button**.
- 3 Disconnect the **AC power supply cord** from the power outlet.

- You cannot charge the battery when supplying power to the camera-recorder from the AC adapter.

### CAUTION:

- This unit can be operated at a voltage in the range of 100-240V AC. An AC plug adapter may be required for voltages other than 120 V AC. If a conversion plug is required, consult with your dealer as to which one is to be purchased.
- Disconnect the AC power supply cord from the power outlet when the unit is not going to be used.

# Adjusting the hand strap

---

Adjust the hand strap to suit your hand.

- 1** Open the cover and adjust the length.
- 2** Close the cover.
  - Make sure the cover is fully closed.

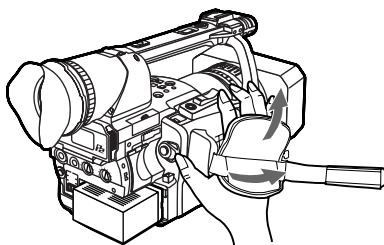

# Attaching the shoulder strap

---

Attach the shoulder strap and use it as a precaution against dropping the camera.

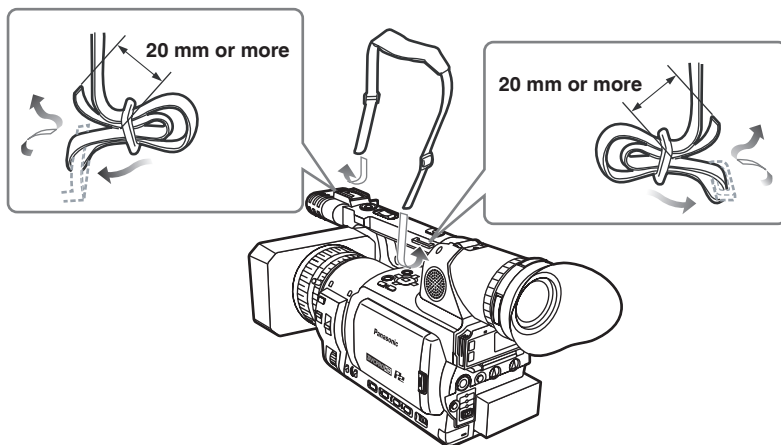

# Detaching and attaching the lens hood

---

## Detaching the lens hood

- Loosen the screw and turn the lens hood counterclockwise to detach it.

## Attaching the lens hood

- Turn the lens hood clockwise and fix in position with the screw.
- Be sure to attach the lens hood cap to protect the lens when not in use.

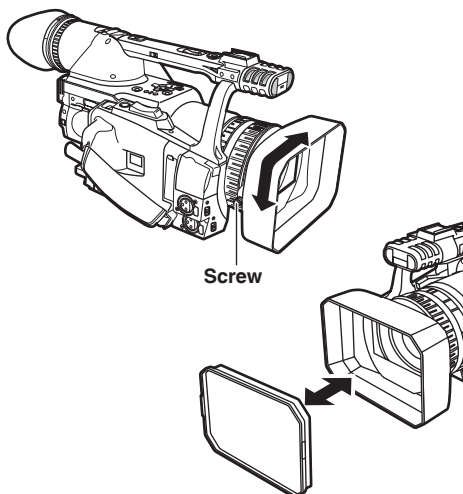

# The remote control

## Insert the battery

- 1 Push the catch in the direction shown by arrow (1) to remove the holder.

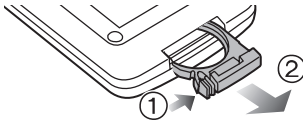

- 2 Insert the battery with the “+” marked side facing up.

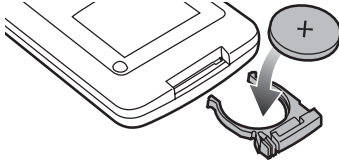

- 3 Return the holder to its original position.

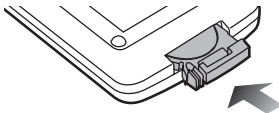

- When the battery (CR2025) has run out, replace it with a new one. (The battery lasts about one year, depending on the frequency of use.)  
If the remote control unit fails to work even when it is operated near the camera-recorder's remote control sensor, the battery has run out.
- Keep the battery out of the reach of children.

## Remote control setup

When using two camera-recorders simultaneously, set this camera-recorder and the remote control to either [VCR1] or [VCR2] so the remote control does not operate the wrong camera-recorder by mistake.

### Setting

#### • Wireless remote control

Press the STOP (■) and STILL ADV (▶▶) buttons at the same time to set the remote control unit for use with VCR1.

Alternatively, press the STOP (■) and STILL ADV (◀◀) buttons at the same time to set the remote control unit for use with VCR2.

When the battery in the remote control unit is replaced, the remote control unit is set for use with VCR1.

#### • Camera

In the setup menu, OTHER FUNCTIONS screen, REMOTE, set to VCR1 or VCR2. (Page 114)

If different settings are used for the camera-recorder and remote control unit, “REMOTE” lights in red on the viewfinder and LCD monitor.

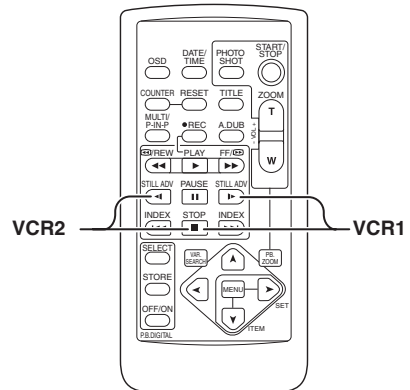

# Turn on/off the camera

While pressing the lock release, move the POWER switch to ON or OFF.

## Turn on the camera:

The mode lamp (CAMERA) lights red (CAMERA mode) and the camera is now in the shooting standby mode.

## Turn off the camera:

The red mode lamp goes out.

### • Power saving mode

The camera-recorder performs as follows when you pause or leave it in standby mode for about 5 minutes, and do not perform any specified operations.

ON: The camera recorder turns off automatically

OFF: Do not switch OFF the camera. In the TAPE mode, however, put the cylinder head alone in a stopped (standby) status.

See the setup menus, OTHER FUNCTIONS screen, POWER SAVE (page 117) for details.

- When the operation mode buttons flash in sequence starting with the top one and the power then goes off, it means that there is no charge left in the battery. Recharge the battery.

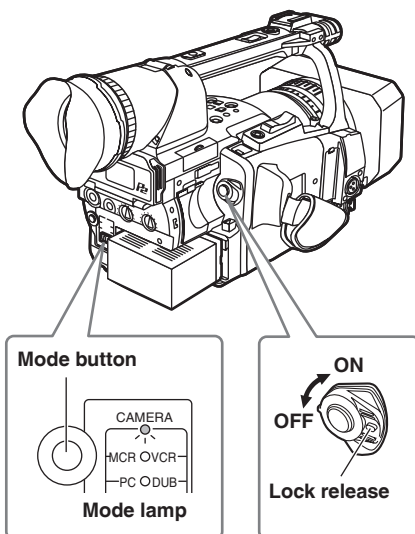

# Tally lamp

The tally lamp can be made to light up during shooting by selecting "ON" as the REC LAMP set-ting in the OTHER FUNCTIONS screen. (Page 115)

When the camera-recorder is in any of the following states, the tally lamp blinks.

- When an operation initiated by the remote control unit has been received (8 blinks/sec.)
- When shooting starts in the TAPE mode (8 blinks/sec.)
- When the end of the tape is reached (4 blinks/sec.)
- When trouble occurs regarding tape running systems (4 blinks/sec.)
- When the remaining battery capacity runs out (4 blinks/sec.)
- When the available recording space on the P2 card or tape or the battery power is low (1 blinks/sec.)
- When removing the P2 card during access (4 blinks/sec.)
- When there is no recording space left on the P2 card (4 blinks/sec.)

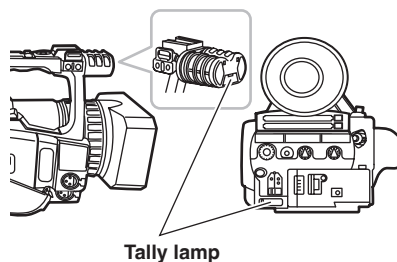

# Viewfinder

This camera has two viewfinders; one is a miniature LCD in the viewfinder and the other is a retractable 3.5-inch LCD.

Use the viewfinder that best suits the application and shooting conditions.

- The brightness and hue may differ between the images appearing on the viewfinder and LCD monitor and those displayed on a TV monitor. To see how the final images will appear, check them on a TV monitor.

## Using the viewfinder

- 1 Set the POWER switch to ON and check that images appear in the viewfinder.**

- Keep the LCD monitor closed.



- 2 Adjust the viewfinder's angle so that the screen is positioned where it is easiest to see.**

- You can move the view finder out to about 90° perpendicular to the camera.

- 3 Adjust the diopter adjustment lever so that you can see the characters on the viewfinder screen clearly.**

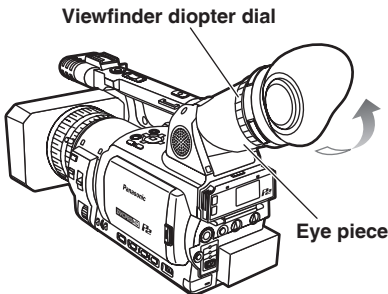

**Do not point the eye piece at the sun.**

Doing so may damage the parts inside.

## Fitting the eye cup

Attach the eye cup by aligning the projections on the eye cup holder and eye cup and fitting them together.

- Turning the eye cup after attaching it may cause the eye cup holder to come off. If the eyecup holder does come off, see "Cleaning the Viewfinder" (page 126) for details on how to refit it.

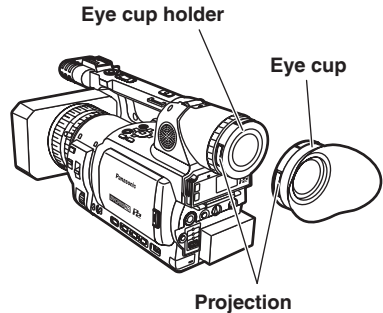

## Viewfinder (continued)

### Using the LCD

- 1 Set the POWER switch to ON.
- 2 Press the OPEN button in the direction shown by arrow (1) to open the LCD.

It can open out to 120 degrees. Do not try to open it further as this will damage the camera.

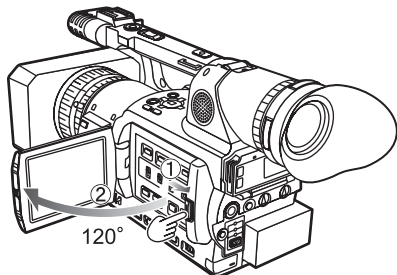

- 3 Position the LCD monitor where it is easiest to see.

- The monitor can be rotated 180° toward the lens and 90° toward you.
- Do not apply unnecessary force to the open LCD. This can damage the camera.

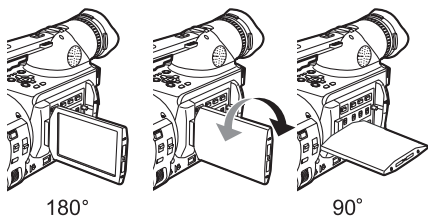

### Emphasizing outlines

Emphasizing the outlines of the images you see in the viewfinder or on the LCD makes it easier to focus.

Emphasizing the outlines does not effect the images you shoot.

- 1 In CAMERA mode, press EVF DTL.
  - “EVF DTL ON” appears on the screen for about 2 seconds.

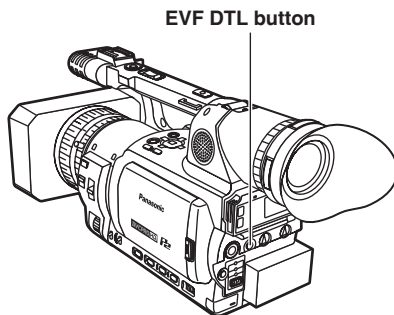

Press EVF DTL again to return to the original display. “EVF DTL OFF” appears on the screen for about 2 seconds.

- 
- Ensure the LCD is fully closed.
  - Both the LCD and viewfinder come on when you have rotated the LCD to face in the same direction as the lens for self-portrait shooting.
-

## Adjusting the screen display

**1** Set the POWER switch to ON. (Page 20)

**2** Press the MENU button.



- For menu operation (Page 96)
- You can also use the menu buttons on the remote control. (Page 15)



**3** Viewfinder adjustments

Set YES under EVF SET on the setting menu DISPLAY SETUP screen.

### LCD monitor adjustments

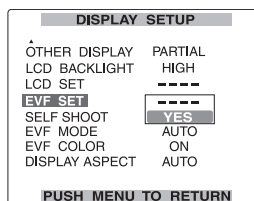
Set YES under LCD SET on the setting menu DISPLAY SETUP screen.



**4** Select the item to be set using the  or  operation button.

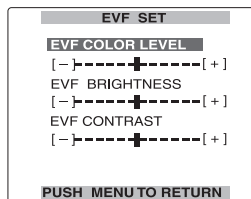

**5** Adjust the selected item using the  or  operation button.

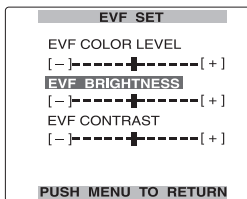

**6** Press MENU three times to exit the menus.



- You can return the settings for EVF SET and LCD SET to the factory settings by selecting the item and pressing COUNTER RESET (if it is possible to change the item at that time).
- The viewfinder remains on when you open the LCD if you have set the EVF MODE in the DISPLAY SETUP screen to ON.
- The viewfinder display can be in color or black and white. (See the setup menus, DISPLAY SETUP screen, EVF COLOR.) The resolution is the same for both of them.

# Setting the calendar

The CLOCK SET value is recorded in the contents (clip), and affects the sequence of playback of the thumbnails. Before carrying out recording, be sure to check and set CLOCK SET and TIME ZONE. This shows you how to adjust the calendar to 5:20 PM on December 25, 2005.

**1** Set the POWER switch to ON. (Page 20)

**2** Press the MENU button.

**3** In the setup menus, OTHER FUNCTIONS screen, TIME ZONE, set the time difference from Greenwich mean time using the  or  operation button. (Page 116)

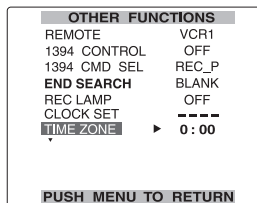

(Example of MENU in the TAPE mode)



Operation button

- For menu operation (Page 96)
- You can also use the menu buttons on the remote control. (Page 15)

**4** In the setup menus, OTHER FUNCTIONS screen, CLOCK SET, select YES.

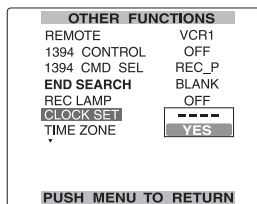

**5** Press the  or  operation button to set YEAR to 2005.

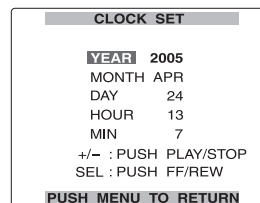

Choose a year between 2000 and 2030.

**6** Press the  operation button to move the setting item to MONTH.

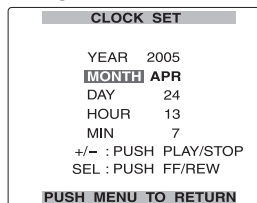

**7** Press the  or  operation button to set MONTH to DEC.

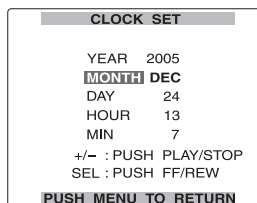

**8** Set DAY, HOUR, and MIN using the method shown in steps 4 and 5.

- This is a 24-hour clock.

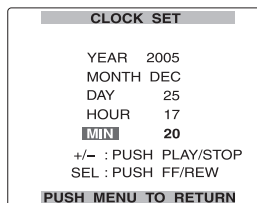

**9** Press MENU three times to exit the menus.

- The clock can vary in accuracy so check that the time is correct before shooting.
- When using the camera overseas, do not set the CLOCK option to the current time, but instead enter the time difference from Greenwich mean time according to TIME ZONE.



## Preparing to shoot using a P2 card

- 1 Switch the MEDIA switch to "P2".
- 2 Set the POWER switch to ON. (Page 20)
- 3 Lift up the viewfinder and open the card slot cover.
- 4 Insert the P2 card securely in the card slot.
  - There are two card slots.
  - Be absolutely sure to close the card slot covers to keep the dust out.

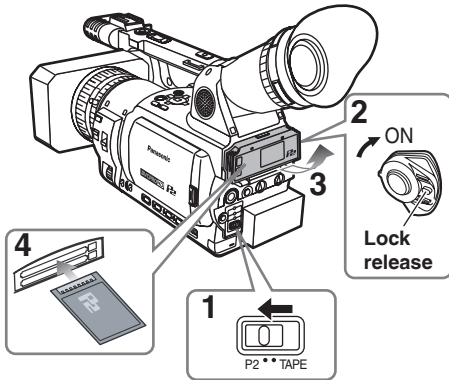

Do not operate the MEDIA switch when the power is switched ON.  
 If you attempt to operate the MEDIA switch, the message "TURN POWER OFF" will be displayed.  
 In this case, switch OFF the power, and then switch it ON again.

## Shooting in auto mode

- 1 Turn the POWER switch to ON. (Page 20)
  - Check that the mode lamp (CAMERA) is lighted red. If not, press the mode button.
- 2 Switch the AUTO/MANUAL switch to AUTO to select auto mode.
  - "A" appears on the viewfinder and LCD screens.
  - The focus, gain, iris and white balance are adjusted automatically.
- 3 Press the START/STOP button (Red) on the POWER switch to start shooting.
  - Press again to return to the camera to the shooting standby mode.
  - Use the handle START/STOP button to make it easier to shoot from low angles.

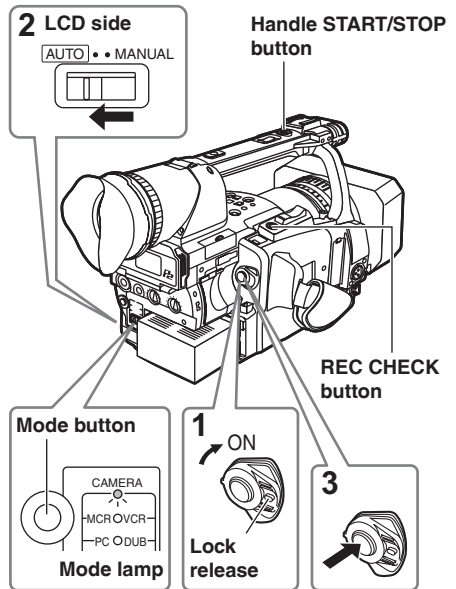

## Checking photos taken (REC CHECK)

In the shooting pause mode, **press the REC CHECK button.**

A few seconds of the last thing you shot play.

- Note that this REC CHECK portion will also be recorded to any equipment you have set up to make backup recordings.
- Only the POWER and START/STOP buttons are operable during REC CHECK.
- The REC CHECK function does not work when PC, MCR or DUB has been selected as the operation mode.

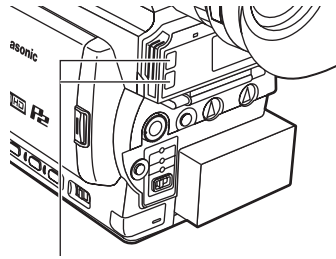

**P2 card access lamp**

## Protecting against a possible erasure

Switch the write-protect switch of the P2 card to [PROTECT].

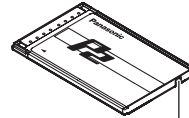

**Write-protect switch**



## P2 card access lamps

### CAMERA mode (MCR)

**Lights green:** Data can be saved onto the cards or loaded from them.

**Blinks green (slow):** No available space on card, card is write-protected

**Lights orange:** Slot that is the object of recording

**Blinks orange :** Data is now being accessed.

**Blinks orange (fast):** A card is now being recognized.

**Both lamps blink orange:** Ejection of card during access

**Off:** Cards have not been inserted or formatted. Insertion of incompatible card.

### PC mode (USB DEVICE)

**Blinks orange:** Data is now being accessed.

**Off:** A status other than access underway.

### PC mode (1394 DEVICE)

**Blinks orange:** Connected

**Off:** Not connected

### PC mode (1394 HOST)

**Lights green:** Access standby.

**Blinks orange:** Data is now being accessed.

**Off:** Cards have not been inserted or formatted. Insertion of incompatible card.

## Formatting P2 cards

- 1 Press the mode button and set it to MCR mode (the MCR/VCR lamp lights).
  - Thumbnails are displayed.

- 2 Press the MENU button.

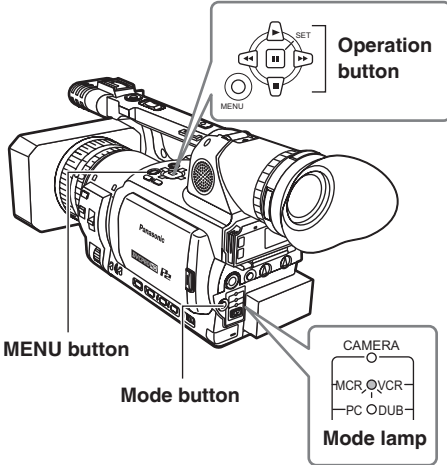

- 3 On the menu, select OPERATION and then FORMAT.

- A screen such as the one shown below appears. Select the number of the slot into which you inserted the P2 card to be formatted. Select EXIT to cancel the formatting.
- When you press the MENU button, the menu display disappears.

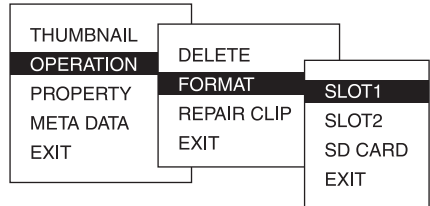

- 4 Select YES on the confirmation screen.

- The selected P2 card is formatted.

## Recording times

Card model	Capacity	DVCPRO 2-channel audio	DVCPRO50 4-channel audio	DVCPRO HD*1	DVCPRO HD 720P/24PN	DVCPRO HD 720P/30PN
AJ-P2C004HG	4 GB	approx. 16 min.	approx. 8 min.	approx. 4 min.	approx. 10 min.	approx. 8 min.
AJ-P2C008HG	8 GB	approx. 32 min.	approx. 16 min.	approx. 8 min.	approx. 20 min.	approx. 16 min.

- The AJ-P2C002SG (2 GB) card cannot be used.
- The displayed available space includes the management area, and so the space available for recording is smaller than this.
- Concerning the division of clips recorded on P2 cards  
When using a P2 card of at least 8 GB in this camera, if the continuous recording time for a single session exceeds the time shown in the following table, recording will be automatically resumed as a different clip. When performing a thumbnail operation (display, delete, restore, copy, etc.) on clips using P2 cards, you can operate them as a single clip. When you are using non-linear editing software and a PC, for example, the clips are displayed individually.

Recording Format	Recording times
DVPRO HD*1	approx. 5 min.
DVPRO50	approx. 10 min.
DVPRO/DV	approx. 20 min.

\*1 The 720P/30PN and 720P/24PN formats are not included in the DVCPRO HD recording format.

- When using any other types of cards, the driver installed in the camera-recorder may need to be updated. (Page 125)
- For the latest information not available in the Operating Instructions, visit the P2 Support Desk at the following Web sites.  
<https://www.pavc.panasonic.co.jp/pro-av/>

## Remove the P2 card

- 1 Lift up the viewfinder and open the card slot cover.
  - Check that the P2 card access lamp is not blinking orange.
- 2 Press the card eject button once, and when the button has popped back up, press it again.
- 3 Remove the P2 card.

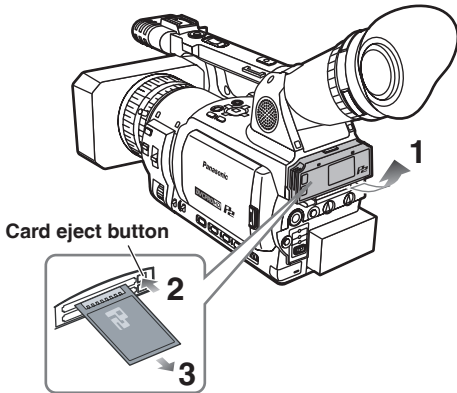

- Do not eject a P2 card while its data is being accessed or while it is being recognized after insertion (the P2 card access lamp is blinking orange).
- If a P2 card is ejected during formatting or while its data is being accessed, "TURN POWER OFF" appears in the viewfinder, and a warning is indicated by an alarm or tally lamp. If this happens, turn the power off and back on again. **When a card is ejected during formatting:** Format the card again.

**When a card is ejected while its data is being accessed:**

The data on the card will not be destroyed, but the clips may be thrown out of order. Check the clips and repair them. (For details on repairing clips, see page 69.)

- During playback, a P2 card inserted into the empty slot will not be recognized and the P2 card access lamp will not light. When playback is completed, the P2 card recognition will begin.
- You can use ACCESS LED on the OTHER FUNCTIONS screen to set the P2 card access lamps so that they will always be off. In this case, either turn off the power or wait until enough time has passed after inserting the cards or stopping operation before ejecting the cards.
- If a P2 card is ejected while thumbnails are displayed, the thumbnail screen is released.

## Preparing to shoot using a tape

- 1 Switch the MEDIA switch to "TAPE".
- 2 Set the POWER switch to ON. (Page 20)
- 3 Slide the OPEN/EJECT switch in the direction shown by the arrow to open the cassette cover.
  - The cassette holder opens automatically.
  - The cassette holder will not open if the camera is not supplied with power (AC adapter or a battery).
- 4 Insert the cassette tape.
- 5 Press PUSH to close the cassette holder.
  - Close the cassette cover only after the cassette holder is completely in position.

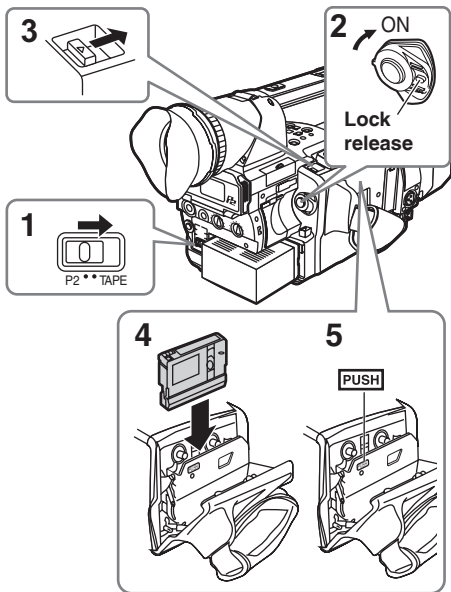

## Shooting in auto mode

- 1 Turn the POWER switch to ON. (Page 20)
  - Check that the mode lamp (CAMERA) is lighted red. If not, press the mode button.
- 2 Switch the AUTO/MANUAL switch to AUTO to select auto mode.
  - "A" appears on the viewfinder and LCD screens.
  - The focus, gain, iris and white balance are adjusted automatically.
- 3 Press the START/STOP button (Red) on the POWER switch to start shooting.
  - Press again to return to the camera to the shooting standby mode.
  - Use the handle START/STOP button to make it easier to shoot from low angles.

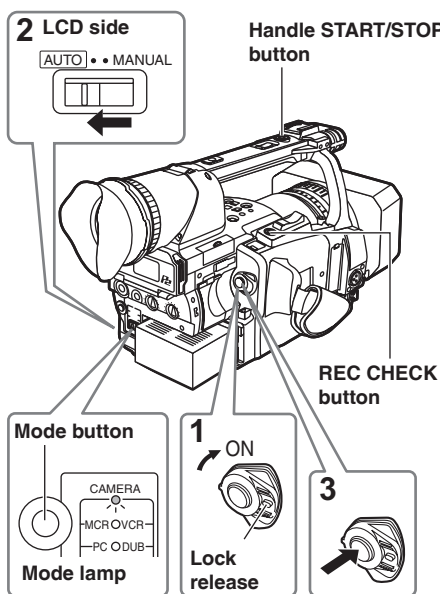

Do not operate the MEDIA switch when the power is switched ON.

If you attempt to operate the MEDIA switch, the message "TURN POWER OFF" will be displayed. In this case, switch OFF the power, and then switch it ON again.

## Checking scenes taken (REC CHECK)

In the shooting pause mode, **press the REC CHECK button.**

A few seconds of the last thing you shot play, and then the camera returns to the shooting pause mode.

- The REC CHECK function cannot be used unless the recording is at least one second long.
- When recording backup images by connecting the equipments using a 1394 cable, the images will not appear during REC CHECK.
- The REC CHECK function does not work when VCR or DUB has been selected as the operation mode.

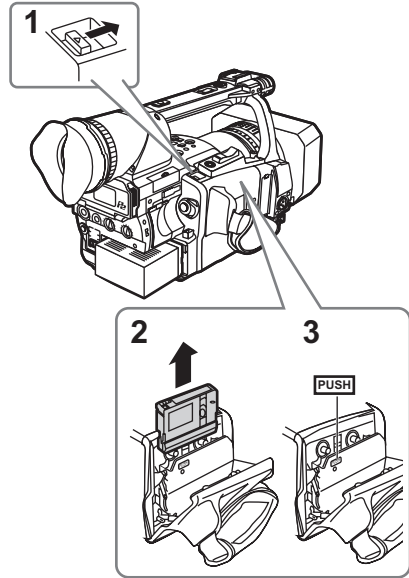

## Remove the cassette tape

**1 Slide the OPEN/EJECT switch in the direction shown by the arrow to open the cassette cover.**

- The cassette holder opens automatically.
- The cassette holder will not open if the camera is not supplied with power (AC adapter or battery).
- A tape cannot be ejected in P2 mode or during recording in TAPE mode.

**2 Remove the cassette.**

**3 Press PUSH to close the cassette holder.**

- Close the cassette cover only after the cassette holder is completely in position.

## Cassette tapes

- You can use tapes with this mark <sup>Mini</sup> DV.

Use the following mini DV cassette tapes with this camera-recorder.

AY-DVM63PQ Professional series tape  
(60 minutes in SP mode)

AY-DVM63MQ Master series tape  
(60 minutes in SP mode)

Do not use 80-minute miniDV cassette tapes.

- Picture quality does not worsen if you shoot in LP mode, but you may notice some block noise and there may be other limitations.

Block noise and feature limitations occur in the following situations.

- When you play a tape on other digital video equipment that you have shot in LP mode on this camera.
- When you play a tape in this camera that you have shot in LP mode on other digital video equipment.
- When you have shot in LP mode and try to play it on other digital video equipment that doesn't have an LP mode.
- During slow motion or still-picture playback
- When using the camera's search functions

- Audio dubbing cannot be performed in the LP mode as the tracks on the tape are narrower than the heads.

### Preventing accidental erasure

To prevent erasing the recordings on a tape by accident, set the tab on the cassette to SAVE.

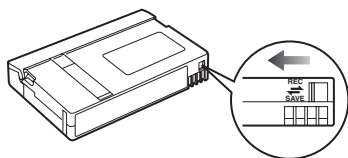

### Tape loading and unloading

- Tapes cannot be loaded or unloaded when the MEDIA switch is set to P2.
- Do not try to insert or eject the tape by just holding the cassette cover.
- Insert and remove cassette tapes after putting the camera-recorder down on a stable, flat surface or hold it to keep it stable.
- Do not force the cassette holder while it is moving. Trying to do so could damage the camera.
- Close the cassette cover only after the cassette holder is completely in position. Trying to close the cover while the cassette holder is moving could damage the camera.
- Close the cassette holder again if you are not going to insert another tape.
- Do not open the cassette cover while you are recording. Recording continues, and the open cover allows outside light and dust to adversely affect the tape.

You can use SD memory cards to save and load SCENE files and USER files. (Page 56)

## Installing and removing the SD memory card

### Installation

- 1 Open the cover, and insert the card while making sure it is oriented in the proper direction.

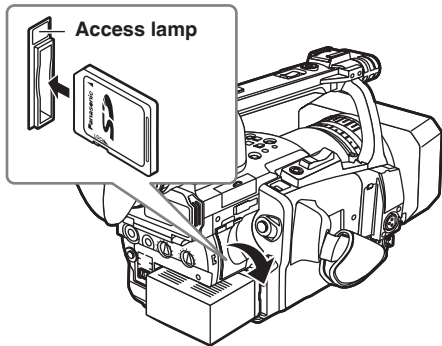

- 2 Close the cover.

### Removal

- 1 Open the cover, and check that the access lamp is not lit.
- 2 Press the card further into the unit, grasp the card, and then remove.
- 3 Close the cover.

## Formatting SD memory card

- 1 Switch the MEDIA switch to "P2".
- 2 Set the POWER switch to ON. (Page 20)
- 3 Press the mode button and set it to MCR mode (the MCR/VCR lamp lights).
- 4 Press the MENU button.

- 5 On the menu, select OPERATION, FORMAT and then SD CARD.

- Select EXIT to cancel the formatting.

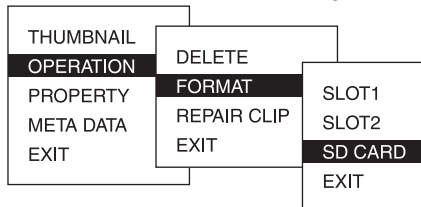

- 6 Select YES on the confirmation screen.

- The selected SD memory card is formatted.

You can also format from the SD CARD FORMAT option on the CARD FUNCTIONS screen. (Page 114)

## Cautions in using SD memory cards

- SD memory cards used with the AG-HVX200 should conform to SD standards. Be sure to format cards using the AG-HVX200. To format SD memory cards using a personal computer, download the dedicated software from the support site. SD memory cards with the following capacity (8MB - 1GB) can be used for the AG-HVX200:

8 MB	16 MB	32 MB	64 MB
128 MB	256 MB	512 MB	1 GB

For the latest information not available in the Operating Instructions, visit the P2 Support Desk at the following Web sites.

<https://eww.pavc.panasonic.co.jp/pro-av/>

- SD memory cards must not be used or stored in an environment where they may be Exposed to high temperatures/humidities; Exposed to water droplets; or Electrically charged.
- Be sure always close the cover when using an SD memory card.
- You cannot use the SD memory card in the TAPE mode.



# Using the zoom function

This camera has a 13 x optical zoom function.  
Zoom with the zoom button or the zoom ring.

## Zoom button

Set the ZOOM switch to SERVO so that you can use the motor-driven zoom.

- T** : Zoom in
- W** : Zoom out

Gently press the zoom button on the viewfinder to zoom slowly, firmly press to zoom faster.

You can change the zoom speed on the handle zoom button by selecting one of three speeds with the HANDLE ZOOM switch.

Set the HANDLE ZOOM switch speeds by going to the setup menus, SW MODE screen HANDLE ZOOM (Page 103)

## Zoom ring

Set the ZOOM switch to MANUAL so that you can use the zoom ring.

- You cannot use the zoom ring if the ZOOM switch is set to SERVO. Trying to use it could damage the camera.

## On the remote control

- Press ZOOM/VOL to zoom with the motor drive.
- Zoom speed is fixed at medium.

HANDLE ZOOM switch

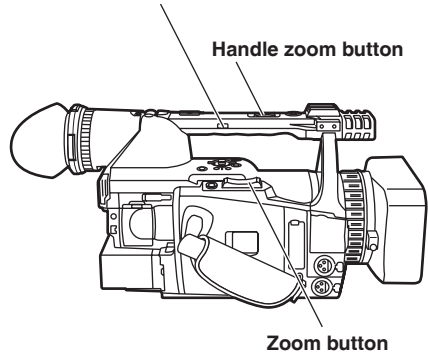

Zoom ring

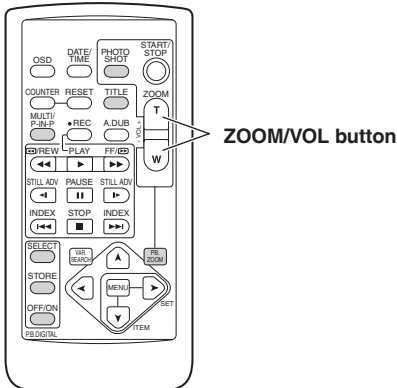
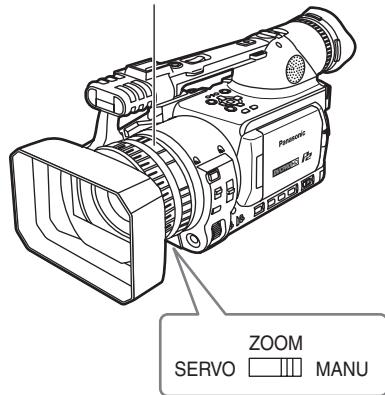

By taking full advantage of the special characteristics of P2 cards, this unit provides frame skipping (undercranking) recording and highspeed (overcranking) recording, which are actually movie techniques, without the use of a frame rate converter. (Either the 30PN or 24PN mode must be set for this.)

Since the camera-recorder records only the effective frames (native recording), recording is possible for between 2 times and 2.5 times as long compared with recording in the 24P, 30P or 60P mode (standard recording).

As with Panasonic's Varicam model (AJ-HDC27 series), this unit also provides a recording format that allows frame rate conversion using nonlinear editing. (Either the 30P or 24P mode must be set for this.)

### 24PN mode:

The camera-recorder shoots in the 24 fps native mode. The video signals delivering images at a rate of 24 fps are recorded in 24 frames. The signals are recorded only in the effective frames so recording is possible for 2.5 times as long.

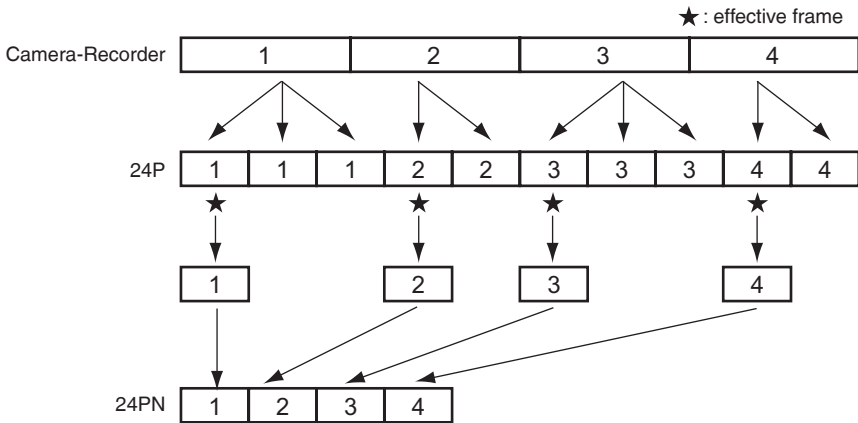

- Before VFR shooting, you must set the recording frame rate and recording format ahead of time.
- You cannot change the frame rates while recording.
- VFR shooting is possible only in progressive-shooting P2 mode with 720 vertical lines.

You can select any of 11 recording frame rates ranging from 12 frames per second (fps) to 60 fps. The list of formats that allow recording by the camera-recorder (Page 129)

**Native recording**

- 1** Using the REC FORMAT (P2) function (page 106) on the RECORDING SETUP screen, select 720/30PN or 720/24PN as the recording format
- 2** Select the appropriate scene file using the SCENE FILE dial.  
If necessary, before doing this, perform the camera settings from the setting menu, and register the scene file. (page 54)
- 3** Using the OPERATION TYPE function (page 100) on the SCENE FILE screen, select FILM CAM, and set the desired recording frame rate using the FRAME RATE function (page 100).
- 4** Press the START/STOP button to start or stop native recording in VFR mode.
  - No signals are output from the 1394 terminal during recording or recording standby in the native mode.
  - Sound is not recorded. However, sound will be recorded when the same frame rate is used for both recording and playback.
  - When a recorded clip lasting a long time is to be played back and imported using a nonlinear editing system that supports Varicams, the UB MODE option on the RECORDING SETUP screen must be set to FRM.RATE.
  - If the effective frame information is to be carried over when recording onto this camera-recorder from a nonlinear editing system that supports Varicams, the 1394 UB REGEN option on the RECORDING SETUP screen must be set to ON.
  - After editing, materials are output from the nonlinear editing system in 1080i/24P or 720P/60P (24P over 60P) format.

**Standard recording**

- 1** Using the REC FORMAT (P2) function (page 106) on the RECORDING SETUP screen, select 720P/60P, 720P/30P or 720P/24P as the recording format
- 2** Select the appropriate scene file using the SCENE FILE dial.  
If necessary, before doing this, perform the camera settings from the setting menu, and register the scene file. (page 54)
- 3** Using the OPERATION TYPE function (page 100) on the SCENE FILE screen, select FILM CAM, and set the desired recording frame rate using the FRAME RATE function (page 100).
- 4** Press the START/STOP button to start or stop standard recording in VFR mode.
  - Sound is recorded.
  - In the case of a nonlinear editing system that supports Varicams equipped with an effective frame extraction function, you can upload even undercrank or overcrank shooting materials as is. (The UB MODE option on the RECORDING SETUP screen must be set to FRM.RATE.)
  - After editing, materials are output from the nonlinear editing system in 1080i/24P or 720P/60P (24P over 60P) format.
  - The 24P format is used for 2:3 pull-down recording; the 30P format is used for 2:2 pull-down recording.

There may be slight discrepancies between the recording frame rate displayed and the frame rate at which the images are actually recorded. Refer to the table below.

Recording frame rate displayed	60	48	36	32	30	26	24	22	20	18	12
Frame rate at which images are actually recorded	59.94	48.17	35.68	32.11	29.97	26.44	23.98	22.48	19.55	17.98	12.26

## Using variable frame rates (VFR)

## Standard speed shooting for movie production

When making movies to show on a screen, a frame rate of 24 fps (frames per second), which is the same as for films, is the norm (1x speed). If you use the settings below, the same kind of playback as with screenings can be obtained. By using the 720P progressive mode and cine-like gamma, high-quality film-like images can be achieved.

Recording format (REC FORMAT)	720P/24P (2:3 pull-down)	720P/24PN (native recording)
Recording frame rate (FRAME RATE)	24 fps*	

## Standard speed shooting for making commercials and dramas

When producing commercials and dramas to be shown on a TV screen, as in the case of HDTV/SDTV and other broadcasts, a frame rate of 30 fps (frames per second) is the norm (1x speed). If you use the settings below, the same kind of playback as when the programs are broadcast can be obtained. Commercials and music clips will be recorded with a high film-like picture quality while the number of frames is also ideally suited to TV broadcasts.

Recording format (REC FORMAT)	720P/30P (2:2 pull-down)	720P/30PN (native recording)
Recording frame rate (FRAME RATE)	30 fps*	

## Undercrank shooting

This way of shooting provides quick motion effects used to present such scenes as the movement of clouds, someone standing among crowd of people, and moves made by martial artists. If, for instance, you have shot scenes using the 24P recording format for specifying the playback frames, you can double the speed of the quick motion effects by setting the VFR recording frame rate to 12 fps.

Recording format (REC FORMAT)	720P/24P, 720P/24PN	720P/30P, 720P/30PN
Recording frame rate (FRAME RATE)	Set to 22 fps or lower.*	Set to 26 fps or lower.*

- In the case of the 720P/24P and 720P/30P formats, the quick motion effect can be obtained by using a nonlinear editing system to process what has been recorded.

## Overcrank shooting

This way of shooting provides slow motion effects used to show car chases as well as action scenes, climax scenes and other dramatic presentations. If, for instance, you have shot scenes using the 30P recording format for specifying the playback frames, you can obtain slow motion effects with the speed halved by setting the recording frame rate to 60 fps. Images in the 720P progressive format will create smoothly flowing slow motion sequences with a high picture quality.

Recording format (REC FORMAT)	720P/24P, 720P/24PN	720P/30P, 720P/30PN
Recording frame rate (FRAME RATE)	Set to 26 fps or higher.*	Set to 32 fps or higher.*

- In the case of the 720P/24P and 720P/30P formats, the slow motion effect can be obtained by using a nonlinear editing system to process what has been recorded.

\* You can select any of 11 recording frame rates ranging from 12 frames per second (fps) to 60 fps. (Page 100)

# Shooting in 1080i/480i progressive mode

Selecting 1080i/30P, 1080i/24P, 1080i/24PA, 480i/30P, 480i/24P or 480i/24PA in the REC FORMAT option (page 106) of the setting menu RECORDING SETUP screen enables shooting in progressive mode.

## 30P mode:

Shoot 30 frames a second in the progressive mode.

For output and recording, the 30-frame-per-second signal is converted to 60-field-per-second interlace.

This mode gives you high quality images.



## 24P mode:

Shoot 24 frames a second in the progressive mode.

For output and recording, the 24-frame-per-second signal is converted to 60-field-per-second interlace using the widely used “2:3” ratio.

This gives you images similar to a movie shot with film.

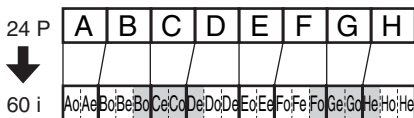

## 24P advanced mode:

Shoot 24 frames a second in the progressive mode.

For output and recording, the 24-frame-per-second signal is converted to 60-field-per-second interlace using “advanced” conversion.

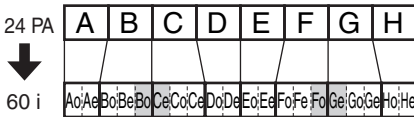

With the “2:3” method, frames [BoCe], [CoDe], [FoGe], and [GoHe] shown in the illustration would be extended over different frames which can cause a drop in picture quality.

With the 24P advanced method, however, frames [BoCe] and [FoGe] are cut out, leading to a reduction in image quality loss.

If you also use a system compatible with the advanced method, editing will also yield better quality images than those shot in the normal 24P mode.

- If you are not going to do your editing on such a system, use the normal 24P method for shooting.

## Note the following when shooting in progressive mode.

- You cannot have a gain of 18dB.
- Set the shutter speed to 1/50 (OFF) or 1/60 for best results.
- There may be a slight delay to the start of recording when you use the 24P or 24P advanced modes because 5 frames are recorded at a time. When using a tape, the shortest possible recording time is three seconds.

# Shooting in manual mode

Set the unit to manual mode when manually adjusting the focus, iris, gain and white balance.

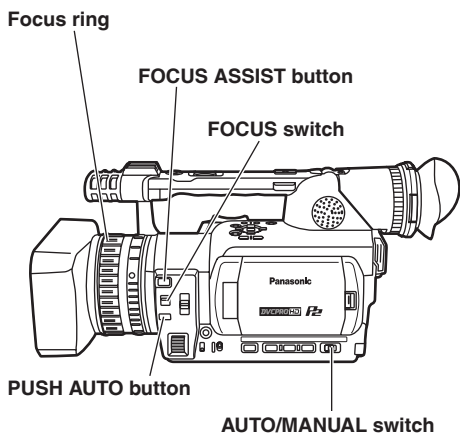

## Switching to manual mode

If the camera is in auto mode, use the AUTO/MANUAL switch to switch to manual mode ( **A** on the viewfinder and LCD goes out).

## Manual focusing

**1** Use the AUTO/MANUAL switch to switch to manual mode.

**2** Use the FOCUS switch to choose how to control focusing.

**A (AUTO):**

Auto focus mode

**M (MANUAL):**

Manual focus mode

Turn the focus ring by hand.

**∞ :**

The camera first focuses on infinity, then it switches to manual focus.

The FOCUS switch automatically moves back to M (MANUAL) after you move it to ∞.

### Temporarily switching to auto focus

Even if you have switched FOCUS to M (MANUAL) the camera will focus automatically while you press down PUSH AUTO.

- Auto focus may not work properly if there is flickering.  
Select a shutter speed suited to the ambient light. (Page 50)
- If the auto focus mode is set with any format except 60i and 60P, controlling the focus will take slightly longer than in the normal focus mode.
- If you have set ON for the AF item on the setting menu AUTO SW screen, auto focusing will occur regardless of the position of the FOCUS switch when the auto mode has been established. (Page 105)
- During macro shooting “AF” and “MF” will be displayed in a frame on the screen.

## Using focus assist

When you press the FOCUS ASSIST button, the area at the center of the screen will be enlarged, making it easier for you to bring the subjects into focus. The normal display is restored about 10 seconds after the focus ring has been operated. This is useful when focusing manually. This function is enabled only during recording or recording standby in the HD modes of 1080i and 720P, and it does not work in external input mode.

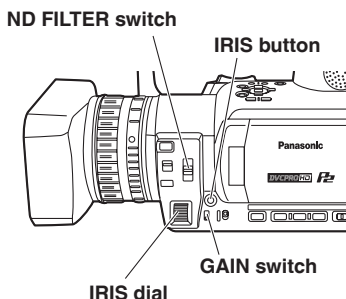

## Iris adjustments

- 1** If the camera is in auto mode, use the **AUTO/MANUAL** switch to switch to manual mode. (Page 38)
- 2** Press the **IRIS** button to switch how to adjust the aperture of lens.  
**AUTO IRIS:** Adjust the iris automatically.  
**MANUAL IRIS:** Adjust the iris manually.
- 3** Turn the **IRIS** dial to adjust the aperture of lens when in the manual iris mode.  
 In the auto iris mode, the lens iris can be corrected using this dial.

Set the direction of the IRIS DIAL and aperture control in the setup menus, SW MODE screen, IRIS DIAL. (Page 103)

If you have set ON under A.IRIS on the setting menu AUTO SW screen, auto iris will be forcibly selected when auto mode has been established. (Page 105)

This unit's iris F number when it is open is F1.6 at full WIDE and F2.8 at full TELEPHOTO.

The iris display in the viewfinder or on the LCD when the iris is open is OPEN at full WIDE and F2.8 or OPEN at full telephoto.

## Adjusting the gain

When the display is dark, increase the gain to brighten the display.

- 1** If the camera is in auto mode, use the **AUTO/MANUAL** switch to switch to manual mode (**A** goes out). (Page 38)
- 2** Switch the gain with the **GAIN** switch.
  - L:** Set here under normal conditions. (0 dB)
  - M:** Increase the gain of the image amplifier. (The default value is 6 dB.)
  - H:** Increase the gain of the image amplifier. (The default value is 12 dB.)

You can change the M and H gain values using the MID GAIN and HIGH GAIN items on the setting menu SW MODE screen. (Page 103)

If ON is set for the setting menu AUTO SW and you have selected a setting other than OFF under AGC, auto gain will be provided when auto mode has been established regardless of the GAIN switch position. (Page 105)

When the recording frame rate is less than 22 fps and when a slow shutter speed (1/15) has been set, the gain is fixed at 0 dB regardless of the GAIN switch setting. (Pages 34 and 50)

## Light intensity adjustments

Use the ND FILTER Switch to change the ND Filter used (filter to change light intensity).

- OFF:** ND filter is not used.
- 1/8:** Cuts light intensity by up to about 1/8.
- 1/64:** Cuts light intensity by up to about 1/64.

## Shooting in manual mode (continued)

### Adjusting the white balance

In order to reproduce the white accurately, adjust the ratio between the three RGB primary colors. If the white balance is not adjusted properly, not only will the white be reproduced poorly but the color tones of the entire screen will also be downgraded. When you are shooting in manual mode, readjust the white balance whenever lighting conditions change.

You can save adjustments and reselect them by setting the WHITE BAL switch to A or B.

You can also use the preset values.

Use the settings to suit the shooting conditions.

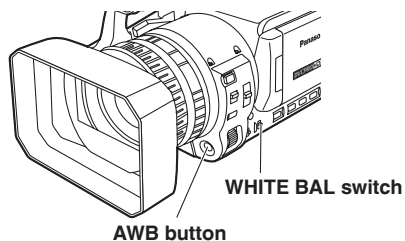

### White balance adjustments

**1** If the camera is in auto mode, use the **AUTO/MANUAL** switch to switch to manual mode. (Page 38)

**2** Set the shutter speed. (Page 50)

**3** Place a white pattern in a location with the same lighting conditions and light source as the subject, then zoom in and fill the whole screen with white.

Something white (a white cloth or wall) near the subject can be used instead.

- Do not include bright spotlights in your shot.

**4** Set the **WHITE BAL** switch to **A** or **B** (whichever one you want to save the adjustment in).

**5** Press the **AWB** button.

- Adjustment takes a few seconds. (The following messages appear on the screen.)

#### Message during adjustment

AWB Ach ACTIVE

#### Message after adjustment

AWB Ach OK

An error message appears on the screen when white balance adjustment is not possible.

#### Message when adjustment cannot be done

AWB Ach NG

- White balance cannot be adjusted if the Auto Tracking White (ATW) function is working. If you have set ON under ATW (Auto Tracking White) on the setting menu AUTO SW screen, ATW will be selected when auto mode has been established regardless of the WHITE BAL switch position. (Page 105)

Error messages	Adjustments
LOW LIGHT	Increase light or increase the gain.
LEVEL OVER	Reduce light or decrease the gain.

Make the necessary adjustments if one of the above error messages appears, then try adjusting the white balance again.

- If the messages repeatedly appear even after trying a number of times, consult your dealer.



## Adjusting the white balance (continued)

### Using presets

Use this feature when you have no time to make white balance adjustments.

**1** If the camera is in auto mode, use the **AUTO/MANUAL** switch to switch to manual mode (A on the viewfinder and LCD goes out).

**2** Set the **WHITE BAL** switch to **PRST**.

The current white balance value appears.

- White balance values 3200 K and 5600 K are preset in the PRST position.

Guide to the preset values

P3.2K (3200 K): halogen light

P5.6K (5600 K): outdoors

**3** Press the **AWB** button.

White balance switches between 3200 K and 5600 K.

### Black balance adjustments

In order to reproduce the black accurately, adjust the zero level of all three RGB primary colors. If the black balance is not adjusted properly, not only will the black be reproduced poorly but the color tones of the entire screen will also be downgraded.

It is not normally necessary to adjust the black balance. Adjust it when:

- You use the camera for the first time
- You use the camera after not using it for a long time
- The ambient temperature changes greatly
- You switch to the normal (OFF) shutter speed or to slow shutter
- You switch between the progressive and normal (60i) modes

Press the **AWB** button to automatically adjust the white balance.

Press and hold the **AWB** button to adjust the black balance.

- As the white balance is adjusted first when you press the **AWB** button, make the necessary preparations for this.
- You cannot adjust the black balance while you are shooting.

### Message during adjustment

ABB ACTIVE

### Message after adjustment

ABB END

### Auto Tracking White (ATW)

You can allocate the ATW feature to one of the positions on the **WHITE BAL** switch (A, B, or PRST). Allocate it by going to the setup menus, **SW MODE** screen, **ATW**. (Page 103)

The ATW feature is set to work in the auto mode at the time of shipping. (Page 105)

If you use the ATW feature whenever you are shooting, the camera automatically adjusts the white balance as you shoot.

- The ATW feature automatically determines the current shooting environment and adjusts the white balance accordingly. Depending on the environment, there may be some error in the adjustment.

Use the procedure described on the preceding page whenever you need more precise white balance.

Do not block the white balance sensor when using the ATW feature. ATW will not work if you do.

### White balance sensor

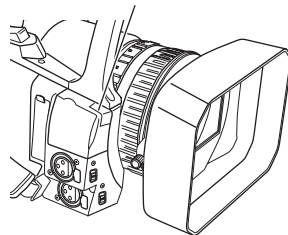

# Shooting techniques for different targets

## Low-angle shooting

Use the START/STOP button on the handle to make it easier to shoot from low angles.

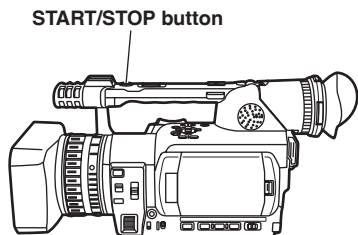

## Self-portrait shooting

Images in the LCD when it is turned 180 degrees for self-portrait shooting may appear unusual. You can make them appear better by reversing left and right. Go to the setup menus, DISPLAY SETUP screen, SELF SHOOT, and select MIRROR.

Shooting in mirror mode has no effect on what you actually shoot and record.

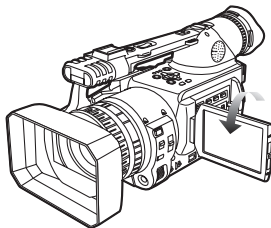

## Zebra pattern

Press the ZEBRA button in the camera mode to show the zebra pattern or marker on the screen so you can check the brightness of the subject. Parts that may be whited out through over exposure are shown as a zebra pattern.

- Very bright
- Reflecting parts

You can remove most overexposed parts by adjusting the iris and shutter speed in the manual mode to remove the areas with zebra patterns. The display changes as follows each time you press the ZEBRA button.

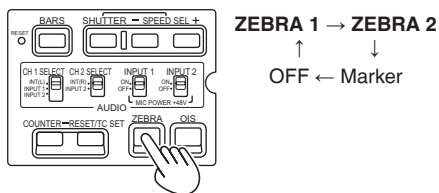

In the setup menus, DISPLAY SETUP screen, ZEBRA DETECT 1 and ZEBRA DETECT 2, set the brightness for the zebra patterns. (Page 112)  
The zebra pattern you have set appears as a percentage on the display for about 2 seconds.

## Marker

If you press the ZEBRA button again while the zebra pattern is being displayed, a marker appears in the center of the display (if you have set the setup menu, DISPLAY SETUP, MARKER to ON). The brightness of the areas near the screen center can be checked as a percentage (0% to 99%). "99%↑" appears if the percentage is over 99.

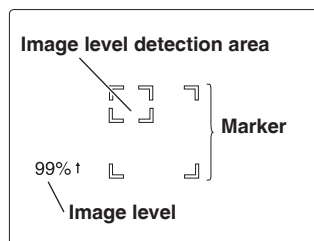

The normal display reappears if you press the ZEBRA button again.

### Checking and displaying shooting status

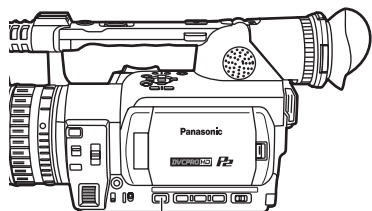

DISP/MODE CHK button

When you hold down the DISP/MODE CHK button during recording standby or recording, all the information including the setting status of the shooting functions and a list of functions allocated to the USER buttons, will be displayed. When you release the button, the normal display will be restored.

When you push the DISP/MODE CHK button during recording standby or recording, all the information will be unshown. When you press the button again, the normal display will be restored. The information is retained even if you turn off the unit's power or switch to another media or operation mode.

### Changing the image size

When recording in 480i mode, you can change the size (aspect ratio) of the images that you record. Select the aspect ratio in the setup menus, CAMERA SETUP screen, ASPECT CONV. (Page 102)

- For menu operation (Page 96)

#### **NORMAL:**

Recorded in the regular 4:3 aspect ratio



#### **LETTER BOX:**

Recorded in the 16:9 aspect ratio.

Black bands are recorded at the top and bottom of the image.



#### **SQUEEZE:**

The recorded images are squeezed horizontally so that they are shown as 16:9 images on a compatible wide-screen television.

If you have selected SQUEEZE, "SQU" appears on the screen.



#### **To change the aspect ratio display of the viewfinder and LCD**

Select the aspect ratio in the setup menus, DISPLAY/SETUP screen, DISPLAY ASPECT. (Page 113)

## Optical Image Stabilizer

Use the Optical Image Stabilizer (OIS) to reduce the effects of camera shake when shooting by hand.

Press the OIS button to turn the function on and off.

 appears on the screen when this function is on. Turn the function off when using a tripod for more natural images.

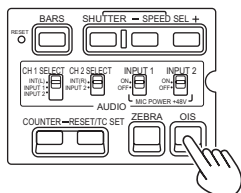

- This function will not be as effective when the vibration is severe or when tracking a moving subject.

## Adding effects to images

Press the USER button you have allocated to the BLACKFADE or WHITEFADE feature to add fading effects to your images. The button's function is forcibly canceled during playback or REC CHECK and also when thumbnails are displayed.

### BLACKFADE:

Press and hold to fade out to black. Audio also fades out. Fade-in starts when the button is released.

### WHITEFADE:

Press and hold to fade out to white. Audio also fades out. Fade-in starts when the button is released.

## Using the USER buttons

You can allocate one of twelve features to each of the three USER buttons.

Use these buttons to change shooting settings quickly or add effects to the images you are shooting.

The following features are allocated to the buttons at the time of shipping.

USER1: WHITEFADE

USER2: BACKLIGHT

USER3: INDEX/MEMO

For details, see the setup menus, SW MODE screen, USER1 to 3. (Page 104)

If you press a USER button to which one of the following functions has been allocated and then turn off the power, that button will revert to the previous setting:

SPOTLIGHT, BACKLIGHT, ATW, ATW LOCK, GAIN: 18dB, FOCUS RING

## Backlight compensation

Press the USER button you have allocated to the BACKLIGHT feature when shooting subjects lit from the back.

BACK appears on the screen.

Backlight compensation adjusts the iris so the subject doesn't come out dark.

Press the same USER button to turn the feature off. (In the manual iris mode, the backlight compensation status is retained even if the backlight compensation is released.)

## Color bars

Press the BARS button to output a color bar screen to a television or monitor so you can adjust them. Press the button again to turn the feature off.

## Shooting techniques for different targets (continued)

### Adjusting the volume while shooting

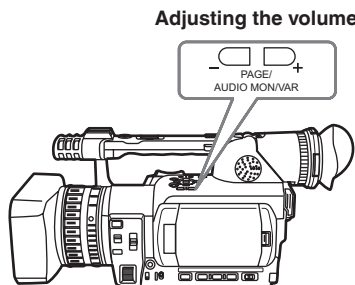

If you are monitoring the sound through headphones while shooting, you can adjust the volume with the PAGE, AUDIO MON/VAR button.

- To adjust the recording level (Page 53)

### Backup recording

If you have connected equipment to the 1394 terminal (pages 77 and 78), you can make automatic backup recordings of whatever you are shooting.

- In the setup menus, OTHER FUNCTIONS screen, 1394 CONTROL and 1394 CMD SEL, select how to control the equipment you have connected. (Page 114)
- Select the settings below for the following items on the DISPLAY SETUP screen (page 112) for backup recording when using a tape.
  - OFF for VIDEO OUT OSD
  - OFF for DATE/TIME

#### Note the following when backup recording.

- When performing backup recording while a tape is used:
  - If either of the following settings have been selected, **the OSD will be output to the 1394 output at all times except when the unit is in the recording mode.**
    - When ON has been set for the VIDEO OUT OSD option on the DISPLAY SETUP screen (page 112)
    - When a setting other than OFF has been selected for the DATE/TIME option on the DISPLAY SETUP screen (page 112)
- Bear in mind that the OSD may be recorded inadvertently if backup recording is performed when a setting other than OFF is selected for the 1394 CONTROL option (page 114) on the OTHER FUNCTIONS screen.

- If the DATE/TIME button on the remote control is pressed, **the date and time will be output to the 1394 output regardless of whether recording is underway or the recording standby status is established.**
- Menu settings are retained even if you turn the power off. So if you use the camera-recorder with the settings for backup recording still in effect, images on media in any unit that connected may be overwritten. After backup recording, check the menu item settings before you operate the camera-recorder.
- If you use another AG-HVX200 as the external unit for backup recording, select "OFF" for 1394 CONTROL on the external unit and set it to MCR/VCR mode.
- Backup recording may not work properly if you connect two or more external units.
- Use a DV (IEEE1394) cable of 4.5 m or less for connection.
- Set the external unit up to receive 1394 signals before backup recording.
- You can have a media in the external unit start recording automatically when the media in this unit is almost finished. Set 1394 CONTROL (page 114) to "CHAIN".
- Note that images are recorded even when you perform a rec check if a P2 card is being used: When a tape is used, no images are output during rec check.
- You cannot perform backup recording when the unit is set up for native recording.
- Backup recording does not work in three of the special recording modes of the P2 card: Interval recording, One-shot recording and Loop recording. (Pages 47 and 48)
- Backup recording does not work during direct shooting (page 66) in MCR mode.

When recording to a P2 card, making the settings in the RECORDING SETUP screen (page 106) enables special recording functions such as Pre-recording, Interval Recording, One Shot Recording, and Loop Recording.

This can be used only when the OPERATION TYPE option in the SCENE FILE screen (page 100) is set to VIDEO CAM with the 1080i/60i, 720P/60P, and 480i/60i and 30P recording formats.

### Pre-recording (PRE REC)

This function is used to start recording a certain number of seconds (approx. 3 seconds for HD recordings or approx. 7 seconds for 480i recordings) before actual recording starts.

#### 1 Select ON under PREREC MODE. (Page 106)

- For menu operations (Page 96)

#### 2 Press the START/STOP button.

Pre-recording starts.

- This function does not work during IEEE1394 input recording, transitions from playback to recording, loop recording, interval recording, or one-shot recording.
- Immediately after switching from the MCR mode to CAMERA mode, immediately after turning on the camera-recorder's power or immediately after changing the PRE-REC option setting, it may not be possible to record the images and sound before the time mentioned above has elapsed even if the recording has been started straight away.

### Interval recording (INTERVAL REC)

This function is used to repeat a cycle of recording one frame and then going on standby for a set time.

#### 1 Select INTERVAL under REC FUNCTION. (Page 106)

- For menu operations (Page 96)

#### 2 Set the time INTERVAL TIME. (Page 106)

#### 3 Press the START/STOP button.

The operation of recording one frame and then going on standby for the time that was set under INTERVAL TIME is repeated.

To stop operation, press the  among the operation buttons.

To release the function, either turn off the unit's power or select NORMAL under REC FUNCTION.

- The following displays will appear on the left of the operation status display.  
While recording is underway: I-REC lights up.

In temporary standby: I-PAUSE lights up.

While recording is stopped: The "I-" of I-PAUSE flashes.

However, if the duration selected in step 3 is less than 2 seconds, I-REC will flash while recording is underway in accordance with the set time.

- The pre-recording function does not work.
- No sound is recorded.
- All data recorded while this mode is active will be contained in one file.
- No guarantees are made for the 1394 output images.

### One-shot recording (ONE-SHOT REC)

This function records a single shot at each unit of time which has been set.

#### 1 Select ONE SHOT under REC FUNCTION. (Page 106)

- For menu operations (Page 96)

#### 2 Set the recording time using ONE-SHOT TIME. (Page 106)

#### 3 Press the START/STOP button.

Recording continues for the duration set in step 2 and then goes on standby.

To stop operation, press the  among the operation buttons.

To release standby, either turn off the unit's power or select NORMAL under REC FUNCTION.

- The following displays will appear on the left of the operation status display.  
While recording is underway: I-REC lights up.  
In temporary standby: I-PAUSE lights up.  
While recording is stopped: The "I-" of I-PAUSE flashes.
- No other operations are acknowledged during operation.
- The pre-recording function does not work.
- No sound is recorded.
- All data recorded while this mode is active will be contained in one file.
- No guarantees are made for the 1394 output images.

### Loop recording (LOOP REC)

This function is used to record first on one card and then on the next when you have inserted two P2 cards into the card slots. If there is not enough free memory remaining on the second card, recording returns to the first card whose data will then be overwritten. When data is overwritten, the saved clips are deleted, and then the new clips are recorded in their place.

#### 1 Select LOOP under REC FUNCTION. (Page 106)

- For menu operations (Page 96)

#### 2 Press the START/STOP button.

Recording starts.

To stop operation, press the START/STOP button.

To release the function, either turn off the unit's power or select NORMAL under REC FUNCTION.

- The following displays will appear on the left of the operation status display.  
While recording is underway: L-REC lights up.  
While recording is stopped: L-PAUSE flashes.  
When there is not much free memory:  
 LACK L- flashes.
- Use two P2 cards each with a recording capacity of more than one minute. Recording stops when either card is ejected.
- This function does not work during IEEE1394 input recording.
- The pre-recording function does not work.

### 2-slot continuous recording

If you insert two P2 cards into the two card slots, this function allows you to record continuously on the two cards.

You can also record continuously on three or more cards by replacing one card while data is being recorded on the other. (Hot swap recording)

If you allocate SLOT SEL to a USER button under USER (page 104) on the SW MODE screen, you can switch the slot with the card on which data is to be written using a one-touch operation.

- You cannot change slots while recording so do this during recording standby.
- Does not support hot swap playback.

### Shot mark function

The marks attached to the thumbnails of clips are called shot marks. On the thumbnail screen monitor you can select only those clips with a shot mark and display them or play them back.

During recording, when you press the USER button to which the SHOT MARK function has been allocated, MARK ON appears in the LCD monitor or the viewfinder, and a shot mark is set for the thumbnail of the clip being recorded. If you press the button again, the shot mark is released. You can also set or release the shot marks by performing the thumbnail operations for clips. (Page 66)

### Text memo recording

This function adds text memos at the video points on the clip now being recorded or played back. When you press the USER button to which the INDEX or MEMO function has been allocated, the text memo signal will be recorded at that point. (Page 57)

On the thumbnail screen you can select only those clips where text memos have been added, and then either display those clips or play them back. You can record up to a hundred text memos per clip.

You will need the latest updated version of P2 Viewer to edit the text memos. (Page 57)

- You cannot record text memos during interval recording or one-shot recording.



## Finding specific scenes (image search)

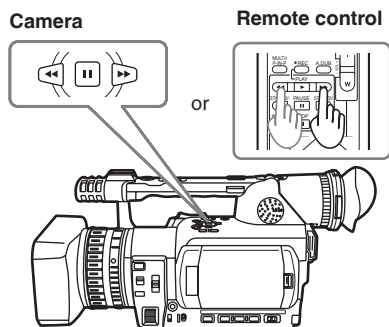

While in the shooting standby mode, you can search through any images you have shot. This is useful when you want to find a point from which to continue shooting so two scenes come one after the other.

### 1 Press ►► or ◀◀ in the shooting standby mode.

The tape plays forward or backward while you are pressing the button.

### 2 Release the button when you find the point you are looking for.

The camera returns to shooting standby mode.

- The scenes may not connect smoothly for certain recording states.

## Index recording

When you press the USER button to which the INDEX/MEMO function has been allocated at any point during shooting or recording, the index signals are recorded if a tape is being used. When the same USER button is pressed in shooting or recording pause mode, recording standby status is established for the index signals. The index signals are recorded when shooting or recording is started. You can conduct searches (index searches) during playback by recording these signals. (Page 75)



With artificial lighting and especially fluorescent lights and mercury-vapor lamps, the luminance changes in synchronization with the power line frequency. When this frequency is 50 Hz, mutual interference will occur between the camera-recorder's vertical sync frequency (approx. 60 Hz) and the lighting frequency (50 Hz). This means that the white balance may change periodically. Before shooting in areas with artificial lighting or adjusting the white balance, set the shutter speed as follows.

Progressive mode	Shutter speed	
	50 Hz	60 Hz
OFF (60i)	1/100	OFF (1/60)
30P	OFF (1/50)	1/60
24P/24PA/24PN	OFF (1/50)	1/60

- The gain is fixed at 0 dB with a shutter speed of 1/15.

## Synchro scan

Set the shutter speed of the synchro scan (used when shooting a television or computer monitor) in the setup menus, SCENE FILE screen, SYNCRO SCAN. (Page 100)

- Adjust the shutter speed to match the frequency of the television or computer monitor to minimize the horizontal noise that appears when shooting such subjects.
- By switching to progressive mode you can also shoot PAL system television screens.
- When the OPERATION TYPE option in the SCENE FILE screen (page 100) is set to FILM CAM, the shutter opening angle can be adjusted from 10° to 350° in 0.5° steps.

Example: When the recording frame rate is set to 24 fps and the exposure time is halved,  $1/24 \div 2 = 1/48 = 180^\circ$  ( $1/24 = 360^\circ$ )

In the default setting (180°), this becomes 1/2 of the exposure time. If it were 90°, it would be 1/4, and if it were 45°, it would be 1/8 of the exposure time.

(Shutter opening angle: This is equivalent to the shutter speed of a film camera, and a wider angle results in a longer exposure to light.)

- If the shutter speed is displayed in blue characters followed by (1/60), you cannot change the shutter speed in the blue characters while the current recording format is used. The speed is fixed at (1/60).

---

You can change the progressive mode in the setup menu with REC FORMAT in the RECORDING SETUP screen. (Page 106)

---

# Switching Audio Input

During shooting, you can record up to four channels of sound. You can also switch the input sound to be recorded on each of the channels to the built-in microphones, external microphones or audio equipment connected to camera. (See table below)

CH1*	CH2**	CH3	CH4
INT(L): Built-in microphone L	INT(R): Built-in microphone R	INPUT1	INPUT2
INT(L): Built-in microphone L	INPUT2	INPUT1	INT(R): Built-in microphone R
INPUT1	INT(R): Built-in microphone R	INT(L): Built-in microphone L	INPUT2
INPUT1	INPUT2	INT(L): Built-in microphone L	INT(R): Built-in microphone R
INPUT2	INPUT2	INT(L): Built-in microphone L	INT(R): Built-in microphone R
INPUT2	INT(R): Built-in microphone R	INT(L): Built-in microphone L	INPUT1

\* The input sound to be recorded onto CH1 can be switched using the CH1 SELECT switch.

\*\* The input sound to be recorded onto CH2 can be switched using the CH2 SELECT switch.

- The CH3 and CH4 input sound is determined automatically by what was selected using the CH1 SELECT switch and CH2 SELECT switch.

However, the following restrictions apply depending on the media and format used. (Page 129, Recording format)

## When tapes are used:

During shooting, it is possible to record sound onto CH1 and CH2 only.

## When P2 cards and the DVCPRO HD or DVCPRO50 format are used:

The recording mode is fixed at 4-channel recording.

## When P2 cards and the DVCPRO25 or DV format are used:

Either 2 or 4 channels can be selected using REC CH SEL on the setting menu RECORDING SETUP screen.

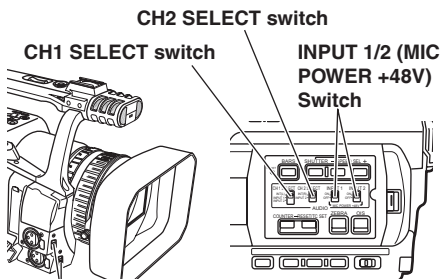

INPUT 1/2 switches

## Using the built-in microphone

### 1 Switch the CH1 SELECT switch to INT (L).

- Audio from the built-in microphone Lch is recorded to audio channel 1.

### 2 Switch the CH2 SELECT switch to INT (R).

- Audio from the built-in microphone Rch is recorded to audio channel 2.

## Using another microphone and audio equipment

### 1 Connect an external microphone or audio equipment to the INPUT 1/2 (XLR 3-pin) terminal. (Page 76)

### 2 Use the INPUT 1/2 switch to switch the audio input.

#### LINE: (audio equipment is connected)

Input level is 0 dBu.

#### MIC: (another microphone is connected)

Input level is -50 dBu.

You can change the input level to -60 dBu in the setup menus, RECORDING SETUP screen MIC GAIN 1 and MIC GAIN 2 (page 106). Be aware that sensitivity will be higher if you choose -60 dBu so you will record more noise.

**3** When using the phantom microphone, set the INPUT 1/2 (MIC POWER +48V) switch to ON.

**ON: (When using the phantom microphone)**  
+48V power supply to INPUT 1/2 terminal.

**OFF: (When a phantom microphone is not connected)**

No power supply for INPUT 1/2 terminal.

- The battery will discharge faster if you use a phantom microphone.
- Set to OFF if you connect equipment not compatible with +48V. You can damage such equipment if you leave the setting at ON.

**4** Use the CH1 SELECT switch to select the input signal to be recorded to audio channel 1.

**INT (L):**

Audio from the built-in microphone Lch is recorded to audio channel 1.

**INPUT 1:**

Audio from a device connected to INPUT 1 terminal is recorded to channel 1.

**INPUT 2:**

Audio from a device connected to INPUT 2 terminal is recorded to channel 1.

**5** Use the CH2 SELECT switch to select the input signal to be recorded to audio channel 2.

**INT (R):**

Audio from the built-in microphone Rch is recorded to audio channel 2.

**INPUT 2:**

Audio from a device connected to INPUT 2 terminal is recorded to channel 2.

- 
- When inputting the microphone signal to channels 1 and 2, connect the microphone to INPUT 2 and switch both CH1 SELECT and CH2 SELECT to INPUT 2.
- 

## Adjusting the recording level

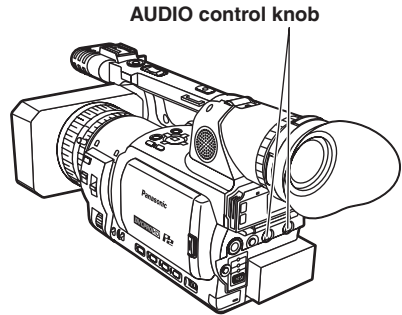

Use the AUDIO control knob to adjust the recording level of the built-in microphone or of audio signals input through the INPUT 1/2 (XLR 3-pin) terminal.

To adjust the volume of the sound for monitoring. (Page 46)

To adjust the recording level of the audio signals, turn the AUDIO control knob while referring to the audio level meter at the bottom left of the viewfinder and LCD monitor, regardless of the MIC ALC option setting (page 106) on the RECORDING SETUP screen of the setting menu.

- There may be a slight difference in the volume level between the P2 mode and TAPE mode.

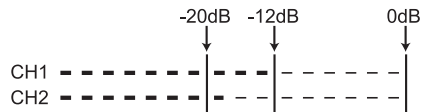

The audio signals input into AUDIO IN/OUT CH1/CH2 (pin jack) terminals can not be adjusted.

---

Check the recording volume level prior to shooting.

- For P2 mode recording, the recording level is set higher than for Panasonic's broadcast-use camera recorders (AJ series).
-

# Using scene files

The settings according to the variety of shooting circumstances are stored in each position of scene file dial.

When shooting, you can retrieve the necessary file instantly using scene file dial.

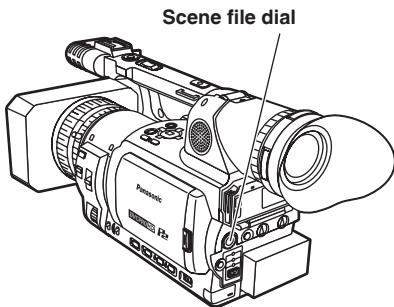

- During recording, the OPERATION TYPE and FRAME RATE (page 100) settings remain unchanged even when the scene file is changed. To change these settings, set the camera-recorder to recording standby state.

When the camera-recorder is shipped from the factory, the following files are stored.

## F1: SCENE

File suitable for normal shooting.

## F2: SCENE FLUO.

File suitable for shooting under fluorescent lights, ie. indoors.

## F3: SCENE SPARK

File suitable for making subjects sharper, such as at weddings.

## F4: SCENE B-STR

File for broadening the contrast of dark parts, such as when shooting sunsets.

## F5: SCENE CINE V

File suitable for shooting movie-like scenes where the contrast is to be emphasized. (The recording format remains unchanged even when the scene file is changed. It must be set using the REC FORMAT option on the RECORDING SETUP screen. (Page 106))



## F6: SCENE CINE D

File suitable for shooting movie-like scenes where the dynamic range is to be emphasized. (The recording format remains unchanged even when the scene file is changed. It must be set using the REC FORMAT option on the RECORDING SETUP screen. (Page 106))

## Changing scene file settings

The setting value of the scene file can be changed. Also you can save the changed scene file to each position of the scene file dial.

**Example: Change the name of the scene file.**

- 1 Set the POWER switch to ON.
- 2 Turn the scene file dial, then select the scene file to be changed.
- 3 In the setup menus, select the SCENE FILE screen.
  - For menu operation (Page 96)
  - You can also use the menu buttons on the remote control. (Page 15)
- 4 Press  and  button to select NAME EDIT.

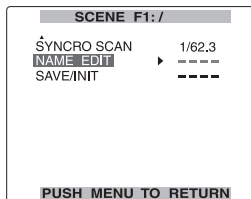

- 5 Press  (or ) button, and use  button to select YES.

Press  button.

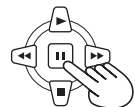
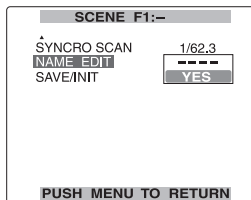

**6** The screen below is displayed, so set the file name of six letters using **[Δ]**, **[▽]**, **[◀]** or **[▶]** button. Set the same as user information. (Page 60)

- Characters that can be set  
Space, A to Z, 0 to 9, ; : < = > ? @ [ \ ] ^ \_ - /  
If the COUNTER RESET button is pressed when the filename has been set, the characters are cleared.

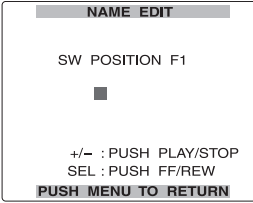

**7** After you finish setting the filename, press the **[MENU]** button.

- The name change will not be completed unless you have finished step 10.

**8** Press **[▽]** button to select **SAVE/INIT.**

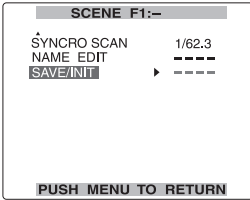

**9** Press **[▶]** button, and use **[▽]** button to select **YES.** Press **[▶]** button.

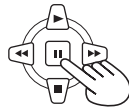
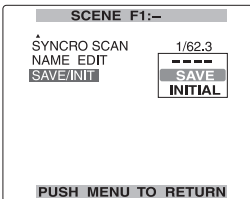

**10** The following screen appears, select **YES**, then press **[▶]** button. (To return to the menu level above, press the **[MENU]** button.)

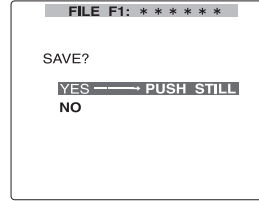

The message below appears, and the changes to the scene file are complete.



**11** Press **[MENU]** twice to exit the menus.

- The original scene file settings will be restored when the power is turned off if **SAVE** has not been selected.
- To return the scene file settings to the factory settings, select **INITIAL** in step 9, then do steps 10 to 11.

You can save up to four scene file settings or other settings as files on an SD memory card, and you can also load them from the card.

- In the case of the scene files, the current settings are automatically saved in the unit, and the saved data is written on an SD memory card. When data has been read from an SD memory card, the current settings are rewritten at the same time as the data saved inside the unit.
- The data in all the scene files, F1 to F6, is rewritten.
- Insert the SD memory card into the unit. Set the MEDIA switch to the P2 position. (Pages 25 and 32)

If you have saved a scene file

- 1 Set the unit's POWER switch to ON.**
- 2 Select SCENE FILE on the setting menu CARD FUNCTIONS screen, select YES, and press the [ ] (or [ ]) button.**

For all other settings, select USER FILE.

- For menu operations (Page 96)
- You can also use the menu buttons on the remote control. (Page 15)

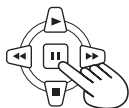
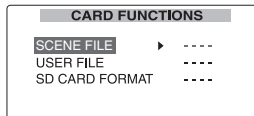

- 3 Select the file number (1 to 4) using the [ ] and [ ] buttons.**

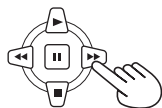
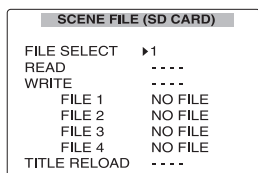

- 4 Select WRITE using the [ ] and [ ] buttons, and press the [ ] button.**

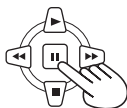
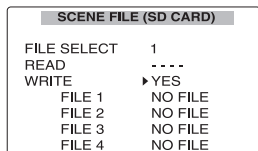

- 5 Select YES using the [ ] button, and press the [ ] button.**

- In the following example, TITLE 1 is the filename. (To change the filename, see the description below.)
- When writing is completed, WRITE OK appears.

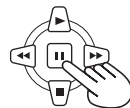
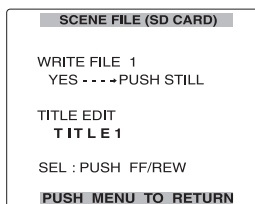

- 6 Press the MENU button four times to cancel the menu mode.**

### To load a file

- 1) Perform steps 1 to 3, select READ in step 4, and press the [ ] button.

When reading is completed, READ OK appears.

### To title a file

- 1) Perform steps 1 to 4.
- 2) Select the first character in the title using the [ ] and [ ] buttons, and press the [ ] button. (The next character can now be selected.)
  - You can input any of the following characters: (space), letters A to Z, numerals 0 to 9, and symbols and punctuation marks : ; < = > ? @ [¥] ^ and \_ . and /
  - You can erase all characters using the RESET button on the camera or the remote control.
- 3) After entering all the characters, press the [ ] button at the left end (or the [ ] button at the right end) of the characters, and then press the [ ] button.

- 
- If WRITE NG FORMAT ERROR appears, format the SD memory card. (Page 32)
  - If WRITE NG WRITE PROTECT appears, release the protected status of the SD memory card.
  - If WRITE NG CANNOT ACCESS appears, quit all other operations (such as playback) before proceeding.
  - If WRITE NG ERROR appears, the SD memory card may be defective. Replace it.
-



You can add the video and audio systems, name of the videographer, shooting location, text memos and other information to the video data you have recorded on the P2 card. This data is called the clip metadata. (Display method: Page 70)

There are two kinds of clip metadata: the data that is recorded automatically during shooting, and the data in the metadata upload file created on the SD memory card which is loaded in the unit. (Loading method: Page 72)

## Creating the metadata upload file on the SD memory card

You will need the latest updated version of P2 Viewer. Download it from the URL address given below, and install it in the computer.

<https://eww.pavc.panasonic.co.jp/pro-av/>

## What the clip metadata consists of

You can set the items underlined below by loading the metadata upload file on the SD memory card. All other items are set automatically during shooting.

### GLOBAL CLIP ID:

This indicates the global clip ID that shows the shooting status of the clip.

### USER CLIP NAME :

This indicates the name of the clip that the user has set.\*1

### VIDEO:

This indicates the recorded image's FRAME RATE, PULL DOWN system and ASPECT RATIO.

### AUDIO:

This indicates the recorded sound's SAMPLING RATE (sampling frequency) and BITS PER SAMPLE (number of quantizing bits).

### ACCESS:

This indicates the CREATOR (name of the person recording), CREATION DATE (recording date), LAST UPDATE PERSON (the person who last updated the data) and LAST UPDATE DATE (date on which the data was last updated).

### DEVICE:

This indicates the MANUFACTURER (manufacturer of the equipment), SERIAL NO. (serial number of the equipment) and MODEL NAME (equipment model name).

### SHOOT:

This indicates the SHOOTER (name of the videographer), START DATE (date and time at which shooting started), END DATE (date and time at which shooting ended) and LOCATION-ALTITUDE/LONGITUDE/LATITUDE/SOURCE/PLACE NAME (shooting location, altitude, longitude, latitude, information source, name of location).

### SCENARIO:\*2

This indicates the PROGRAM NAME, SCENE NO. and TAKE NO.

### NEWS:

This indicates the REPORTER (name of the reporter), PURPOSE (purpose of data collection) and OBJECT (target of data collection).

### MEMO :\*3

This indicates the No. (memo No.), OFFSET (frame position from the beginning of the clip), PERSON (name of the person who recorded the text memo), and TEXT (contents of memo).

- \*1 If there is no information in the metadata upload file, the global clip ID serves as the USER CLIP NAME.
- \*2 When SCENARIO is to be input, you must input the PROGRAM NAME. You cannot input the SCENE NO. and TAKE NO. only.
- \*3 When MEMO is to be input, you must input TEXT. You cannot input PERSON only.

- 
- It may not be possible to load files which have been edited using a viewer other than the P2 Viewer. (In this case, UNKNOWN DATA will be displayed.)
  - Only printable ASCII characters can be displayed by this unit.
-

# Using the Counter

## Counter display (P2 card / Tape)

You can display a counter that indicates how much time has elapsed during shooting or playback.

**COUNTER button**  
Camera or Remote control

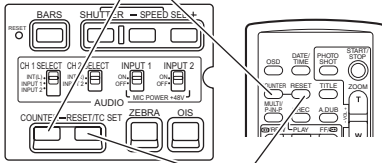

### COUNTER RESET/TC SET button

#### 1 Press the COUNTER button.

Each time you press the button, the display changes as follows. (Page 90)

##### 0 : 00. 00

Counter value

In the P2 mode, the counter is not displayed during playback.

##### M 0 : 00. 00 (Tape only)

Counter value in memory stop mode

##### TC XX : XX : XX : XX

Time code value

##### UB XX XX XX XX

User information

##### FR --- -

Frame rate (30P/24P/24PA) and frame sequence in progressive mode shooting.

##### No display:

Data is not displayed.

### Resetting the counter

Press the COUNTER RESET button while the counter is displayed.

## Memory stop mode (Tape)

After shooting or playback, the tape can first be returned to near the pre-programmed position, and then stopped automatically.

#### 1 Press the COUNTER button to display the counter in memory stop mode.

#### 2 At the desired position on the tape, press the COUNTER RESET button to reset the counter.

#### 3 Proceed with playback or shooting.

#### 4 Press the mode button to switch to the VCR mode. (Page 63)

#### 5 When rewind or fast-forward the tape, it stops automatically near where you reset the counter.

During dubbing, reset the counter value at the OUT point to stop dubbing with memory stop mode. (Page 81)

## 1394TC preset mode

When shooting using a multi-camera, you can synchronously set the initial values of TC. The camera used for synchronization is the MASTER and the camera being synchronized is the SLAVE.

#### 1 Connect a second camera with a 1394 cable and turn both cameras on.

- For connection (Page 78)

#### 2 Put the MASTER camera in CAMERA mode and output a video signal from the 1394 terminal.

- Set both cameras to the same recording format.

Do the remaining steps on the SLAVE camera.

#### 3 Set the SLAVE camera to MCR/VCR mode and in the setup menus, RECORDING SETUP screen, set FIRST REC TC to PRESET mode so the counter shows the TCG.

- You cannot do this if you have selected REGEN.

#### 4 In the setup menus, RECORDING SETUP screen, set 1394 IN PRESET to ON. (Page 108)

- 1394TC appears on the screen.

#### 5 Stop or eject the cassette tape.

#### 6 Press the COUNTER RESET/TC SET button. The TCG value is preset with the TC value from the input 1394 signal.

#### 7 Reset the SLAVE camera to CAMERA mode.

# Charging the built-in battery/Setting the time data

## Recharging the built-in battery

The camera's internal battery saves the date and time. "🔋" appears on the screen of the viewfinder or LCD when the internal battery is running low on charge.

Do the following to recharge it.

Reset the date and time when fully recharged.

### 1 Connect the AC adapter. (Page 17)

- Leave the POWER switch at OFF.

### 2 Leave the camera-recorder like this for about 4 hours.

- The internal battery charges during this time.
- Recharge the battery regularly to ensure correct TC and menu operations.

## Setting the time code

In the setup menus, RECORDING SETUP screen, set the following time code related items. (Page 107)

- TC MODE
  - TCG
  - FIRST REC TC (Tape only)
  - TC PRESET
  - 1394 TC REGEN (appears when in MCR/VCR mode)
- In MCR/VCR mode and 1394 TC REGEN is ON, you cannot change the items shown above.

## Specifying the time code (TC PRESET)

Set TC PRESET so you can record a value of your choice as the initial setting for the time code to be used at the start of recording.

### 1 Set the POWER switch to ON.

### 2 (Tape only) In the setup menus, RECORDING SETUP screen FIRST REC TC, select PRESET.

- For menu operation (Page 96)
- You can also use the menu buttons on the remote control. (Page 15)

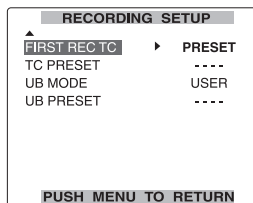

### 3 Press the $\Delta$ and $\nabla$ buttons to select TC PRESET, and press the $\square$ button.

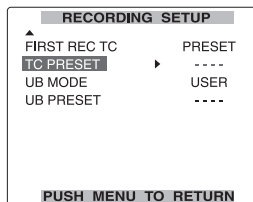

### 4 Press the $\nabla$ button to select YES, and press the $\square$ button.

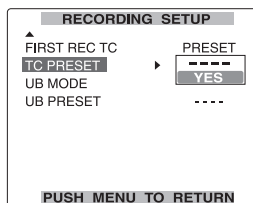

(Continued on the next page)

## Setting the time data (continued)

### 5 When the screen below appears, set the time code value.

Press the **△** and **▽** buttons to select the time code value.

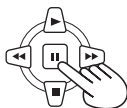
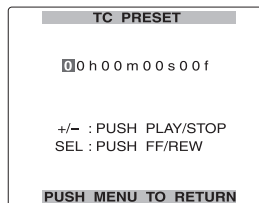

Press the **▶** button to move to the next digit, and press the **△** and **▽** buttons again to select the value.

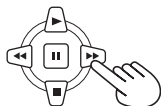
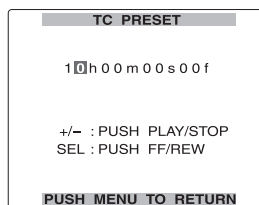

You can reset the time code to zero by pressing **COUNTER RESET**.

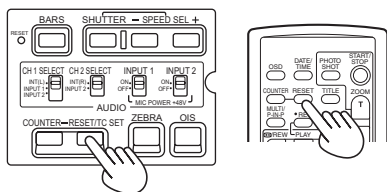

Camera or Remote control

### 6 Press the MENU button when you have finished setting the time code.



### 7 Press the **△** button to select YES, and press the **■** button.

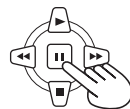
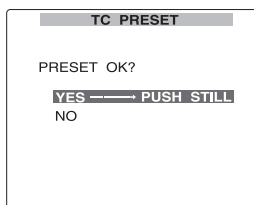

### 8 Press MENU twice to exit the menus.

## Setting user information

Setting user information allows you to store 8-digit information (such as the date and time) in the hexadecimal format on the tape's sub code track. User information is automatically saved in the memory and retained after you turn off the power.

### 1 Set the POWER switch to ON.

### 2 In the setup menus, RECORDING SETUP screen UB MODE, select USER.

- For menu operation (Page 96)
- You can also use the menu buttons on the remote control. (Page 15)

**Example: In the MCR mode**

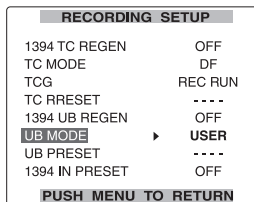

### 3 Press the **△** and **▽** buttons to select UB PRESET, and press the **■** button.

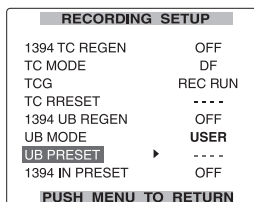

**4** Press the button to select YES, and press the button.

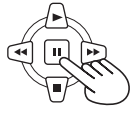
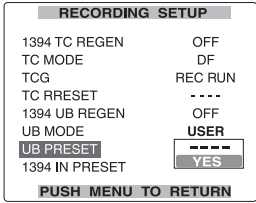

**6** Press the MENU button when you have finished setting the user information.



**5** Set the user information.

Press the and buttons to select the user information characters.

- You can use numbers from 0 to 9 and letters from A to F.

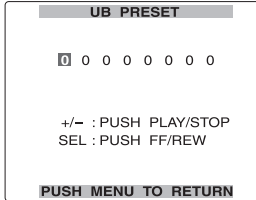

**7** Press the button to select YES, and press the button.

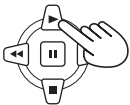
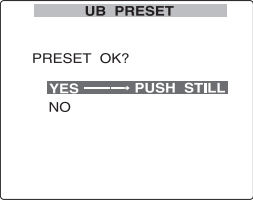

**8** Press MENU twice to exit the menus.

Press the button to move to the next digit, and press the and buttons again to select the characters.

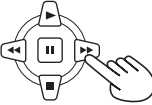
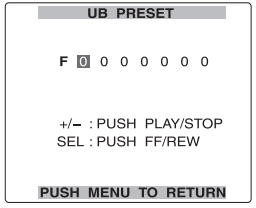

You can reset the user information to nothing by pressing COUNTER RESET.

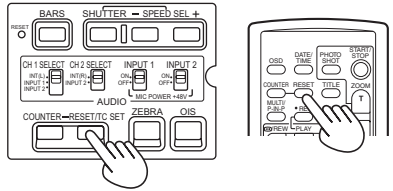

**Camera or Remote control**

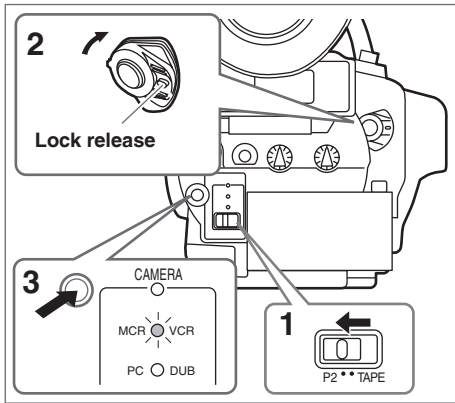

**1** Before turning the POWER switch to ON  
Set the MEDIA switch to the P2 position.

**2** Turn the POWER switch to ON.  
While pressing the lock release, turn the POWER switch to ON.







**3** Press the mode button so the MCR lamp turns on.

The camera is now in the MCR mode.

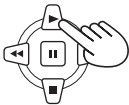
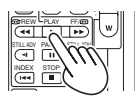
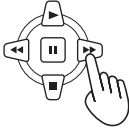
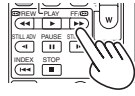
- Each time you press the button, the mode changes as below.  
MCR ↔ CAMERA

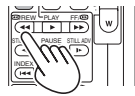
When you press the mode button while MCR is selected, the unit enters the PC (PC connection) mode. (Page 82)

For details on playing back clips using thumbnails, see page 64.

Operations using the OPERATION button	Remote Control
 <p><b>Play (▶)</b> When this button is pressed in stop mode, playback will start from the first clip selected. During playback, the unit enters the variable speed search mode and starts 1x playback. (Page 73)</p>	
 <p><b>Fast-forward (▶▶)</b> When this button is pressed during playback, the clips are advanced from a point in the clip already selected (at four times normal speed). When the thumbnail screen is cancelled, you can also perform this operation while the camera is stopped. When this button is held down, the playback speed becomes faster (32x speed). When pressed during a pause, playback advances one clip.</p>	
 <p><b>Rewind (◀◀)</b> When this button is pressed during playback, the clips are rewound from a point in the clip already selected (at four times normal speed). When the thumbnail screen is cancelled, you can also perform this operation while the camera is stopped. When this button is held down, the playback speed becomes faster (32x speed). When pressed during a pause, playback goes back one clip.</p>	
 <p><b>Stop (■)</b></p>	
 <p><b>Pause (  )</b> Press again to return to playback.</p>	

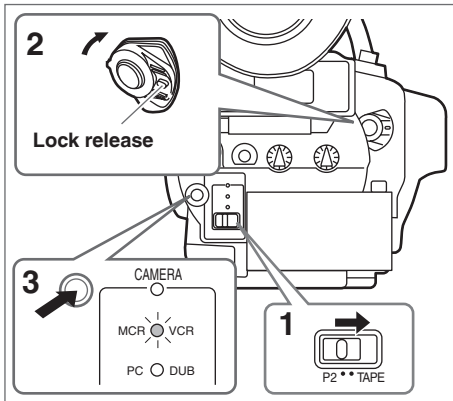







**1** Before turning the POWER switch to ON  
Set the MEDIA switch to the TAPE position.

**2** Turn the POWER switch to ON.  
While pressing the lock release, turn the POWER switch to ON.

**3** Press the mode button so the VCR lamp lights.  
The camera is now in the VCR mode.

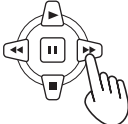
- Each time you press the button, the mode changes as below.  
VCR ↔ CAMERA

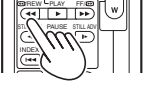
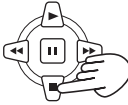
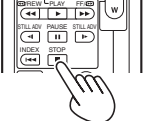
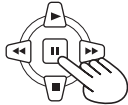
When you press the mode button while VCR is selected, the unit enters the DUB (dubbing) mode. (Page 86)

Operations using the OPERATION button	Remote Control
 <p><b>Playback (▶)</b> While the tape is <u>in the stop mode</u>, the playback starts from where you stopped. <u>During playback</u>, the unit enters the variable speed search mode and starts x1-speed playback. (Page 73) No sound is heard during the playback.</p>	
 <p><b>Fast-forward (▶▶)</b> <u>During playback</u>, the fast-forward playback starts (at ten times normal speed). While the tape is <u>in the stop mode</u>, the unit starts fast-forwarding of tape.</p>	
 <p><b>Rewind (◀◀)</b> <u>During playback</u>, the rewind playback starts (at ten times normal speed). While the tape is <u>in the stop mode</u>, the unit starts rewinding of tape.</p>	
 <p><b>Stop (■)</b></p>	
 <p><b>Pause (  )</b> Press again to return to playback.</p>	

Playback

## Tape protection mode

To protect the tape, this unit automatically switches to stop mode when five minutes elapse in the playback pause state or recording pause state. However, the time until stopping is shorter when in a playback pause state at low temperatures.

Video data created on the P2 card in one shooting session is called a clip. When the MCR mode has been established by the MEDIA switch set to the P2 status, the clips will be displayed on the LCD screen as thumbnails. (When there is a large number of clips, it will take some time for them to be displayed on the screen.)

You can perform the following operations using the thumbnail screen.

- Play, repair and delete clips as well as add and delete shot marks.
- Format P2 cards and SD memory cards.
- Load the metadata (shooting information, etc.) from SD memory cards to the unit.

## Basic thumbnail screen operations

To use the thumbnail menu:

**1** On the thumbnail screen, press the MENU button to display the menu.

**2** Select the item using the  $\Delta$  and  $\nabla$  buttons, and press the  $\square$  (or  $\triangleright$ ) button.

If another menu appears, repeat this step.

- To return to the previous screen, select EXIT and press  $\square$  or press the  $\triangleleft$  button.
- To release the menu mode, press MENU.

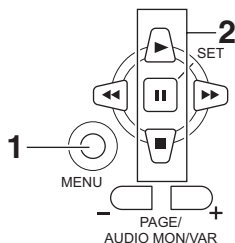

**To select thumbnails:** Select the thumbnails (the yellow frame moves) using the  $\triangleleft$  and  $\triangleright$  buttons, and press the  $\square$  button (the color of the frame changes to blue-green). To scroll the pages, press the PAGE (- or +) button.

**To play back clips:** Select the thumbnail, and press the  $\triangleright$  button. (For details on playback, see page 62.)

- Only clips whose format is the same as recording format 6 shown in the figure below can be played back.

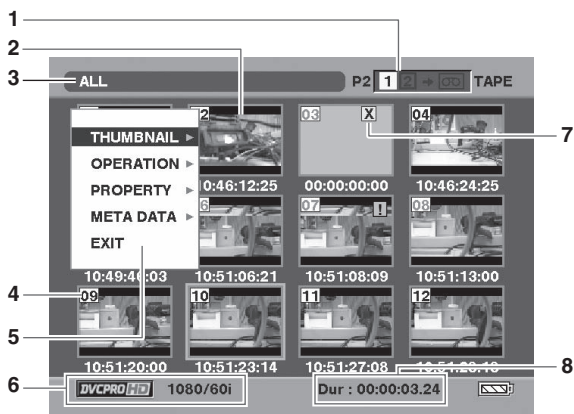

THUMBNAIL	OPERATION	PROPERTY	META DATA
— ALL CLIP	— DELETE	— CLIP PROPERTY	— LOAD
— SAME FORMAT CLIPS	— FORMAT	— CARD STATUS	— RECORD
— SELECTED CLIPS	— REPAIR CLIP	— DEVICES	— INITIALIZE
— MARKED CLIPS	— EXIT	— PROPERTY SETUP	— PROPERTY
— TEXT MEMO CLIPS		— SYSTEM INFO	— EXIT
— SLOT CLIPS		— EXIT	
— SETUP			
— EXIT			

- Thumbnail screens are not output from the COMPONENT OUT terminal.



**1 Slot number/dubbing mode display**

The number of the slot with the P2 card containing the selected clip is indicated here. (The number appears in yellow.) If a clip extends over the P2 cards in two slots, both numbers will appear in yellow. In the dubbing mode, the arrow and tape mark light up.

**2 Thumbnails**

This is where the initial images of the clips are displayed.

**3 Thumbnail display status (Page 67)**

The types of clips displayed as thumbnails appear in this area.

**4 Clip numbers**

The clips are displayed in the order in which they were shot. (up to 2000)  
Clips in the wrong recording format or clips which cannot be played back for other reasons are shown in red.

To play clips indicated by the red numbers, set the format for the REC FORMAT option on the RECORDING SETUP setting menu to the format 6 below. (Page 106)

**5 Menu display**

This is where the menu items are displayed. When EXIT is selected and the  button is pressed, the menu display is cleared, and the original screen is restored.

**6 Recording mode/format display**

This is where the recording mode and format of the recorded images are displayed.

**7 Indicators**** : Shot mark**

This indicates that a clip has a shot mark.

** : Wide**

This indicates that a clip has been recorded in the 16:9 aspect ratio (wide screen). (480i recording)

** : Incomplete clip**

This indicator appears when the recording of a clip extends over two P2 cards and one of the cards is not found in the slot.

** : Defective clip**

This indicator appears for a clip whose recording was defective because the power was cut off during the recording process, for instance.

Clips indicated by the yellow defective clip indicator can be repaired.

Clips indicated by the red defective clip

indicator cannot be repaired so delete them. If a clip cannot be deleted, first back up its data, and then format the P2 card. Clips in the wrong format are indicated by  instead.

** : Voice memo**

This indicates that a clip has a voice memo. (You cannot perform recording/playback with this camera.)

** : Text memo**

This indicates that a clip has a text memo.

** : Edit copy**

This indicates that this is an edit copy clip. (You cannot perform editing with this camera.)

** : Proxy**

This indicates that a proxy has been added and recorded.

(You cannot perform recording with this camera.)

**8 Duration display**

This displays the duration of the selected clip.

### Adding shot marks to clips

Adding shot marks (M) will make it easier to find the clips you are looking for.

- 1 Press the ◀ and ▶ buttons to move the yellow frame to the clip to which you will add a shot mark.**
- 2 Press the USER button to which the shot mark function has been allocated. (Page 104)**

To release a shot mark, repeat the above steps.

### Clearing the thumbnail screen

Before performing setting menu operations (Page 96), you must clear the thumbnail screen. Release this in the same way when the camera-recorder is to be controlled from a nonlinear editor.

- 1 Press the AUDIO DUB/THUMBNAIL button.**

AUDIO DUB  
/THUMBNAIL



The normal playback standby screen (1394 input mode) appears.

### Direct shooting functions

If you press the START/STOP button (red) in MCR mode, the camera mode will be automatically activated, and shooting will start.

## Selecting the thumbnail display method (THUMBNAIL)

You can display the kind of clips you want to see as thumbnails.

You can also set more precisely how you want the thumbnails to appear on the screen.

**1** On the thumbnail screen, press the **MENU** button.

A menu now appears. (Page 64)

**2** Select **THUMBNAIL** using the **▲** and **▼** buttons, and press the **■** (or **▶**) button.

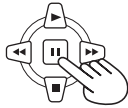

**3** Select the desired item using the **▲** and **▼** buttons, and press the **■** button.

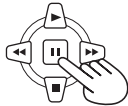
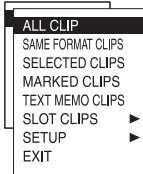

**ALL CLIP:**

All the clips are displayed.

**SAME FORMAT CLIPS:**

The clips in the same recording format are displayed.

**SELECTED CLIPS:**

The clips you have selected are displayed.

**MARKED CLIPS:**

The clips with shot marks are displayed.

**TEXT MEMO CLIPS:**

The clips with text memos are displayed.

The thumbnails at text memo positions, time codes (TC), total number of memos and the current order of the clips are displayed.

To delete a text memo:

- 1) Press the **■** button to display the editing screen, and select the thumbnail.
- 2) Press the **MENU** button to display the menu, and select **OPERATION-DELETE**.

**SLOT CLIPS:**

The clips on the P2 card in the specified slot are displayed.

**SETUP:**

Various setup operations are performed.

**EXIT:**

Select this to return to the last screen.

Proceed to step 4 only when you have selected **SETUP**.

(Continued on the next page)

- 4** Select the desired setting item using the **[A]** and **[V]** buttons, and press the **[M]** button.

**MARKED IND.:**

Select this to set whether the shot mark indicator is to be displayed (ON/OFF).

**TEXT MEMO IND.:**

Select this to set whether the text memo indicator is to be displayed (ON/OFF).

**VOICE MEMO IND.:**

Select this to set whether the voice memo indicator is to be displayed (ON/OFF).

**WIDE IND.:**

Select this to set whether the wide indicator is to be displayed (ON/OFF).

**PROXY IND.:**

Select this to set whether the proxy indicator is to be displayed (ON/OFF).

**DATA DISPLAY:**

Select the time code (TC), user information (UB), shooting time (TIME), shooting date (DATE) or shooting date (DATE TIME) for the area where the clip time is displayed.

**DATE FORMAT:**

Select year/month/day (YMD), month/day/year (MDY) or day/month/year (DMY) as the order for displaying the recording date/time. This format will be the same for the recording date displayed by the clip properties and the recording date displayed by DATA DISPLAY.

**THUMBNAIL SIZE:**

Select LARGE (3x2) or NORMAL (4x3) for full-screen displays of thumbnails.

**THUMBNAIL INIT:**

Select this to return all the above settings to the factory (initialization) settings.

**EXIT:** Select this to return to the last screen.

- 5** Press the **MENU** button to release the menu mode.

## Deleting clips and formatting cards (OPERATION)

You can perform any of the following operations. If necessary, make preparations prior to undertaking the operations.

### Deleting clips

- Select the clip to be deleted, and then press the **[ ]** button.

### Formatting P2 cards or SD memory cards

- Insert the card to be formatted into the unit.
- When a card is formatted, all its data will be deleted.

### Repairing defective clips

- Select the defective clip (indicated by **[X]**) to be repaired. (Clips indicated by the red defective clip indicator cannot be repaired.)

## 1 On the thumbnail screen, press the MENU button.

A menu now appears. (Page 64)

## 2 Select OPERATION using the **[▲]** and **[▼]** buttons, and press the **[ ]** (or **[▶]**) button.

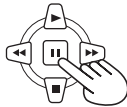
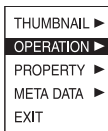

## 3 Select the desired item using the **[▲]** and **[▼]** buttons, and press the **[ ]** button.

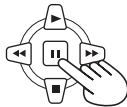
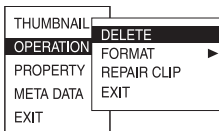

### DELETE:

Select this to delete the selected clip.  
Select YES to delete the clip or NO to cancel the deletion, and press the **[ ]** button.

### FORMAT:

Select this to format a P2 card or SD memory card.

When you move to FORMAT, the card selection screen will appear. Select the P2 slot (SLOT1 or SLOT2) or select SD CARD, and press the **[ ]** button. Select YES to format the card or NO to cancel the formatting, and press the **[ ]** button.

### REPAIR CLIP:

Select this to repair defective clips.

Select YES to repair the clip or NO to cancel the repair, and press the **[ ]** button.

**EXIT:** Select this to return to the last screen.

## 4 Press the MENU button to release the menu mode.

- When clips have been copied by operating Explorer, for instance, the “!” indicator may appear on the clips. If this happens, “!” can sometimes be released by downloading the latest version of the P2 viewer from the web site given below, installing it in your computer, and copying the clips again.

<https://eww.pavc.panasonic.co.jp/pro-av/>

## Checking the clip or card information (PROPERTY)

You can perform any of the following operations. If necessary, make preparations prior to undertaking the operations.

### Checking clip information

- Move the cursor to the clip to be checked.

### Checking the P2 card information

- Insert the P2 card into the unit.

### Checking the SD memory card information

- Insert the SD memory card into the unit.

### Setting the P2 card memory capacity display

### Checking the version of this system

## 1 On the thumbnail screen, press the MENU button.

A menu now appears. (Page 64)

## 2 Select PROPERTY using the $\Delta$ and $\nabla$ buttons, and press the $\square$ (or $\triangleright$ ) button.

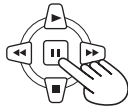
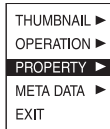

## 3 Select the desired item using the $\Delta$ and $\nabla$ buttons, and press the $\square$ button.

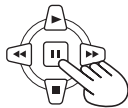
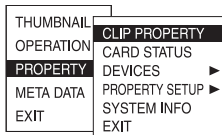

### CLIP PROPERTY:

The information of the selected clip is displayed. (See details at right.)

### CARD STATUS:

The P2 card information is displayed. (Page 71)

### DEVICES:

The SD memory card information is displayed. (Page 71)

### PROPERTY SETUP:

Set the method of displaying the P2 card memory capacity. After selecting P2 CARD CAP, select REMAIN (remaining memory) or USED (memory used), and press the  $\square$  button.

### SYSTEM INFO:

The version of the system in this camera is displayed.

**EXIT:** Select this to return to the last screen.

## 4 To exit the information screen, press the MENU button, use the $\nabla$ button to select EXIT, and then press the $\square$ button.

### Clip information screen

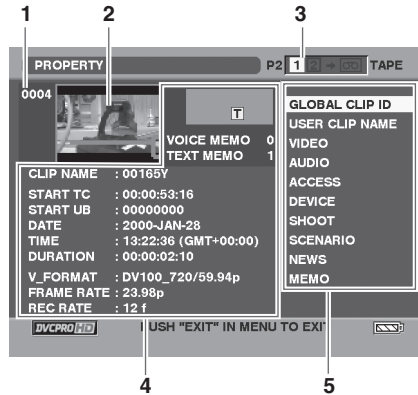

### 1 Clip number

### 2 Thumbnail

### 3 Slot number/dubbing mode display

### 4 Clip information

Various indicators that have been added to the clip and also various kinds of data are displayed. (  $\mathcal{L}$  appears if the P2 card is write-protected)

**CLIP NAME:** Clip name

**START TC:** Time code value when recording started

**START UB:** User information value when recording started

**DATE:** Date when the recording was made

**TIME:** Time when recording started

**DURATION:** Clip length

**V\_FORMAT:** Video signal format

**FRAME RATE:** Playback frame rate

**REC RATE:** Recording frame rate

### 5 Clip metadata

The video and audio formats, videographer information and other detailed data are displayed here.

Select the desired item using the  $\Delta$  and  $\nabla$  buttons, and press the  $\square$  button. (For details on the clip metadata, see page 57.)

## P2 card information screen

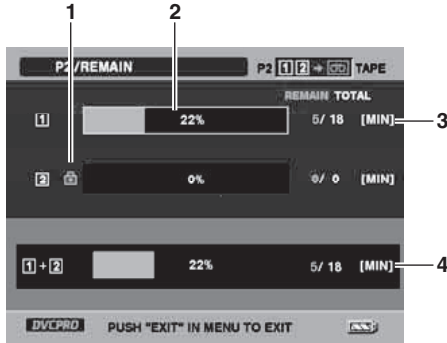

## 1 Write protection mark

## 2 P2 card status

The amount of memory remaining on the P2 card is displayed using a percentage bar. The following displays may appear, depending on the card status.

**FORMAT ERROR:**

An unformatted P2 card has been inserted.

**NOT SUPPORTED:**

A card not supported by the unit has been inserted.

**NO CARD:**

A card has not been inserted.

## 3 P2 card remaining memory/total memory

The P2 card's remaining memory and total memory are displayed here in 1-minute increments. Fractions of a minute are rounded off, meaning the display may not match the slot total.

## 4 Slot total

The figure represents the total remaining memory of the cards in the two slots. If a P2 card is write-protected, its remaining memory will not be included in the total remaining memory.

## SD memory card information screen

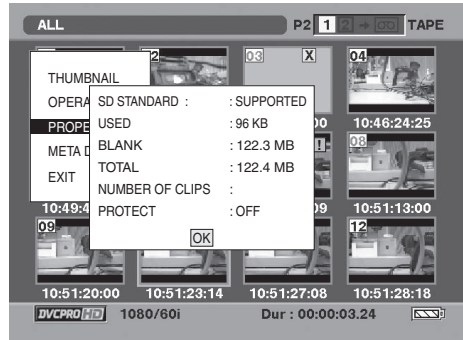
**SD STANDARD:**

This indicates whether the SD memory card was formatted in compliance with the SD standard (SUPPORTED/NOT SUPPORTED).

**USED:** Space used**BLANK:** Space available**TOTAL:** Total space**NUMBER OF CLIPS:** Number of clips**PROTECT:**

This indicates that the SD memory card is write-protected.

## Uploading the metadata (META DATA)

You can perform any of the following operations. If necessary, make preparations prior to undertaking the operations.

### Loading the metadata

- Insert the SD memory card on which the metadata is recorded into the unit. (For details on creating the metadata, see page 57.)

### Selecting whether to record the metadata on the P2 card

### Initializing the metadata inside the unit

### Displaying the metadata inside the unit

## 1 On the thumbnail screen, press the MENU button.

A menu now appears. (Page 64)

## 2 Select META DATA using the ▲ and ▼ buttons, and press the □ (or ►) button.

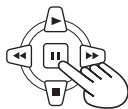
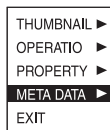

## 3 Select the item using the ▲ and ▼ buttons, and press the □ button.

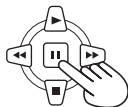
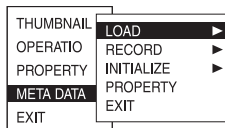

### LOAD:

Select this to load the metadata recorded on the SD memory card into the unit. When the □ button is pressed with operation moved to LOAD, the metadata on the SD memory card will be displayed. Therefore, press the □ button again. Select YES to load the metadata or NO to cancel the loading, and press the □ button.

### RECORD:

Select this to set whether to record the metadata to be loaded into the unit simultaneously on a P2 card. Select YES to record the metadata or NO to cancel the recording, and press the □ button. The factory setting for this mode is OFF.

### INITIALIZE:

Select this to initialize the metadata which has been recorded in the unit. Select YES to initialize the metadata or NO to cancel the initialization, and press the □ button. All the settings including the ON or OFF setting for RECORD are now cleared.

### PROPERTY:

Select this to display the metadata which has been recorded in the unit.

**EXIT:** Select this to return to the last screen.

## 4 Press the MENU button to release the menu mode.



# Useful playback functions

## Variable speed search (P2 card / Tape)

This function enables you to change the playback speed and search for specific scenes.

- 1 Press the ► button during playback.  
On the remote control, press the VAR. SEARCH button.

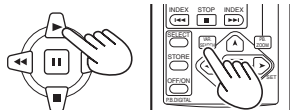

Camera or Remote control

[1x] appears on the screen and the tape is played back at the normal speed. No sound is heard at this time.

- 2 Press the AUDIO MON/VAR button to change the playback speed.

On the remote control, press the [▼] or [▲] button.

- When a P2 card is used, the playback speed increases as follows each time you press the button; 1/5x, 1x, 2x, 4x, 12x, and 24x.
- When a tape is used, the playback speed increases as follows each time you press the button; 1/5x (1/3x in LP mode), 1x, 2x, 5x, 10x, and 20x.
- Press the "+" button to increase the speed and the "-" button to decrease the speed.

Camera

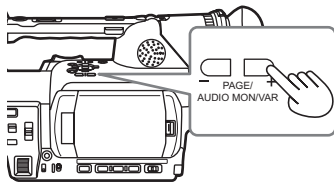

or

Remote control

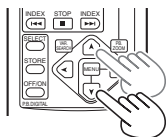

Press the ► button to return to normal playback.

## Slow playback (P2 card / Tape)

- 1 During play, press one of the STILL ADV (◀ or ▶) buttons on the remote control unit.

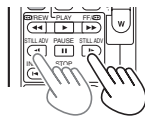

Press the ► button to return to normal playback.

## Fast forward/rewind playback (P2 card)

- 1 During playback of a P2 card, press the ►► (fast forward) or ◀◀ (fast rewind) button.

This performs fast forward/rewind playback at 4x speed.

When this button is held down, the playback speed becomes faster (32x speed).

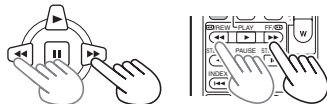

Camera or Remote control

Press the ► button to return to normal playback.

## Fast forward/rewind playback (Tape)

- 1 During playback of a tape, press the ►► (fast forward) or ◀◀ (fast rewind) button.

This performs fast forward/rewind playback at 10x speed.

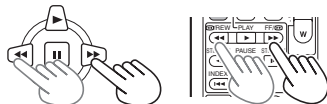

Camera or Remote control

Press the ► button to return to normal playback.

## Useful playback functions (continued)

### Frame-by-frame playback (P2 card / Tape)

- 1 Press the **III** button during playback to set the unit to the pause mode.
- 2 Press the **PAGE/AUDIO MON/VAR** button to play frame-by-frame.  
On the remote control unit, press the STILL ADV (◀ or ▶) button.
  - Press and hold the button to perform frame-by-frame play continuously.



Camera or Remote control

Press the ▶ button to return to normal playback.

### Clip skip (P2 card)

- 1 During playback, press the **III** button to pause the camera.
- 2 Press the ◀◀ (backward) or ▶▶ (forward) button.

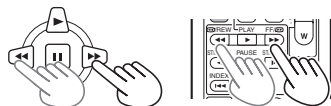

Camera or Remote control

### End search (Tape)

You can find unrecorded parts or the end of the last scene shot.

- 1 In the setup menus, **OTHER FUNCTIONS** screen, **END SEARCH**, set the search method. (Page 115)
  - BLANK:** Find unrecorded parts.
  - REC END:** Find the end of the last scene shot.

- 2 When in the VCR mode  
**Press the END SEARCH button.**

- The unrecorded parts are found, and an unrecorded blank on the tape is found, and a still picture several seconds before the blank is displayed.

When in the camera mode

**Press and hold the END SEARCH button for at least a second.**

- A blank portion of the tape is found, and an unrecorded blank on the tape is found, and the pause status is established several seconds before the blank.

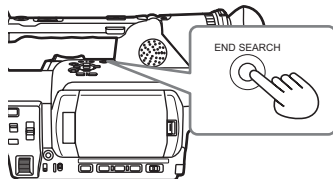

- If you change the tapes, the camera will not be able to find the end of the last scene shot even if you have set REC END.
- If the tape is blank, searching stops at the end of the tape.
- This function may not work properly if there are blank parts near the beginning of the tape or part way through the tape.
- Before recording, check the still picture first.

## Index search (Tape)

This function searches for the index signals (page 49) recorded on the tape. Index searches can be performed using the supplied wireless remote control unit.

### 1 During play, press the INDEX buttons ◀◀ or ▶▶.

- The tape is cued at the next scene after showing [S1] on the screen.
- Each time you press the INDEX button thereafter, [S2] and then [S3] are displayed, and the tape is cued up to the second and subsequent scenes. When the tape is cued up, playback starts from that section. (Up to nine scenes before or ahead on the tape can be specified for cue-up.)

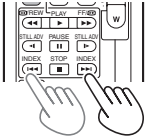

- Press the STOP button (■) to stop the search.

The function may not work properly if the interval between one index and the next is less than one minute.

## Adjusting the volume (P2 card / Tape)

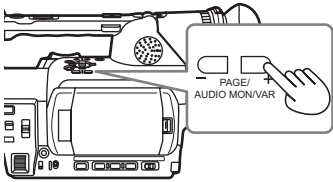

### 1 With the AUDIO MON/VAR button, adjust the volume of the sound that is output from the internal speaker and PHONES jack.

On the remote control, press the ZOOM/VOL button.

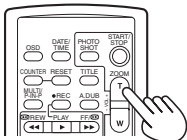

## Viewing images on a television (P2 card / Tape)

You can view the images on a television if you connect the unit to a TV set using an AV cable (not included), S-video cable (not included) or component video cable (included).

### 1 Connect the camera-recorder to the TV set. (Page 79)

### 2 Start playback.

- To show the information that appears on the viewfinder and LCD, press the OSD button on the remote control. (However, the information does not appear when you are recording on tape.) Press the OSD button again to clear the display.

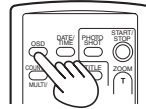

## Checking the date and time (P2 card / Tape)

Press the DATE/TIME button on the remote control to show the date and time of shooting on the screen. The display changes as follows each time you press the button.

- Time
- ↓
- Date
- ↓
- Time and Date
- ↓
- No display

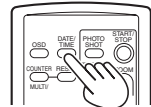

# Connecting external units

## Headphones

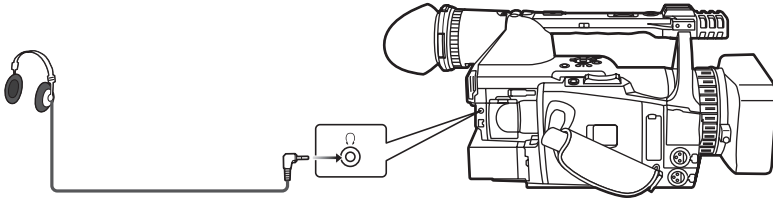

## External microphone

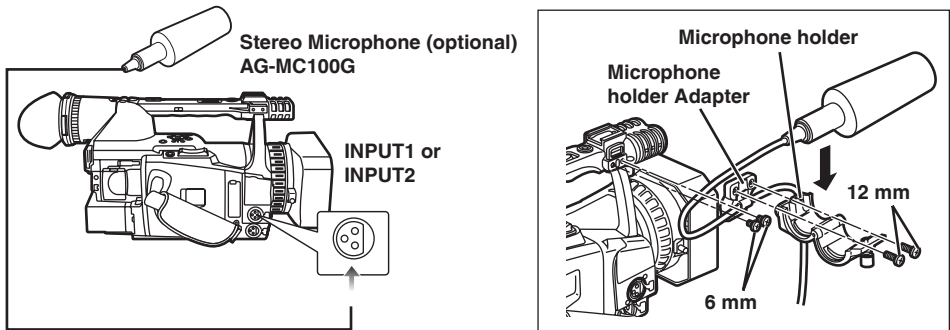

- When attaching an external microphone to the microphone shoe, use the supplied microphone holder and microphone holder adapter.
- When attaching the microphone holder and the microphone holder adapter, be sure to tighten the screws firmly even though you might hear a squeaking sound.

## Computer (non-linear editing/file transfer)

### File transfer/nonlinear editing

#### Computer



#### USB cable (optional)

- For a Windows computer

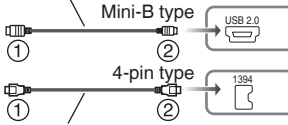

#### 1394 cable (optional)

- For an Apple Macintosh computer

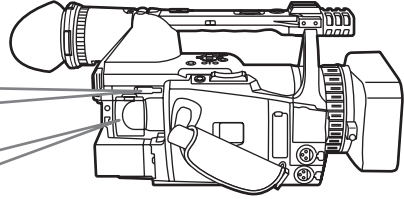

- For details on the computer's conditions and other factors, see page 82.

### 1394AVC transfer/nonlinear editing

#### Computer (Windows/Apple Macintosh)

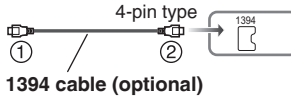

#### 1394 cable (optional)

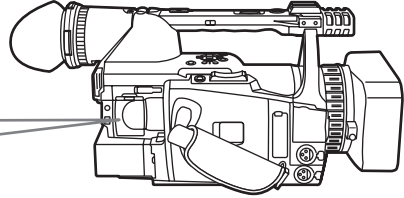

- When controlling this camera from a non-linear editor, cancel the thumbnail screen on the camera. (Page 66)
- No guarantees are given for images and audio signals which are output simultaneously from the camera-recorder while data is being transferred from a computer to the camera-recorder.

#### When connecting the unit to an Apple Macintosh computer

- Connect the 1394 cable after turning on the power of the Apple Macintosh computer. Otherwise, the unit may not be mounted.
- The unit may not be recognized after the Apple Macintosh computer has been placed in the hibernation state by its power-saving setting. In this case, disconnect the 1394 cable and then re-connect it.

#### If the unit is not mounted properly on an Apple Macintosh computer

- When the P2 card access lamp flashes orange
  1. Select [Applications] → [Utilities] → and start up [Disc Utility].
  2. Select a grayed-out volume among volumes of the X.X GB Panasonic disc, and click "Mount."
- When the P2 card access lamp is off  
Eject the P2 card, and insert it again. If the unit is still not mounted, disconnect the 1394 cable and then re-connect it.

## Hard disk drive (data copying)

#### Hard disk drive

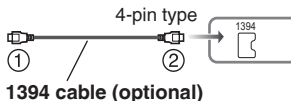
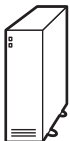

#### 1394 cable (optional)

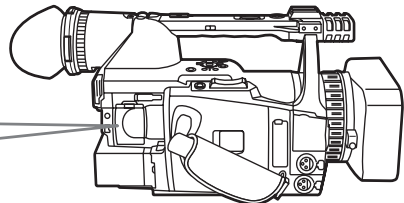

## Connecting external units (continued)

- Before proceeding to connect or disconnect 1394 cable, be absolutely sure to turn off the power of the units.
- **Before proceeding to connect the unit which uses a 6-pin type 1394 connector, carefully check the shape of the 1394 cable and the connectors on the 1394 cable. Connecting a connector upside down may damage the parts inside the unit and cause malfunctioning. Furthermore, connect the 1394 cable to the unit which uses a 6-pin type 1394 connector first. (① → ②). The above also applies to USB cable as well.**
- Do not apply force when connecting 1394 cable to 1394 connector as this may damage the connector.
- When connecting to a PC, attach the ferrite core (provided) to the 1394 cable in such a way that the whole ferrite core fits within about 5 cm from the PC's connectors.

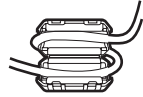
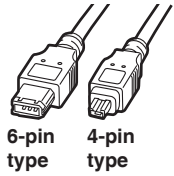

Ferrite core (provided)

## Digital video equipment (Dubbing)

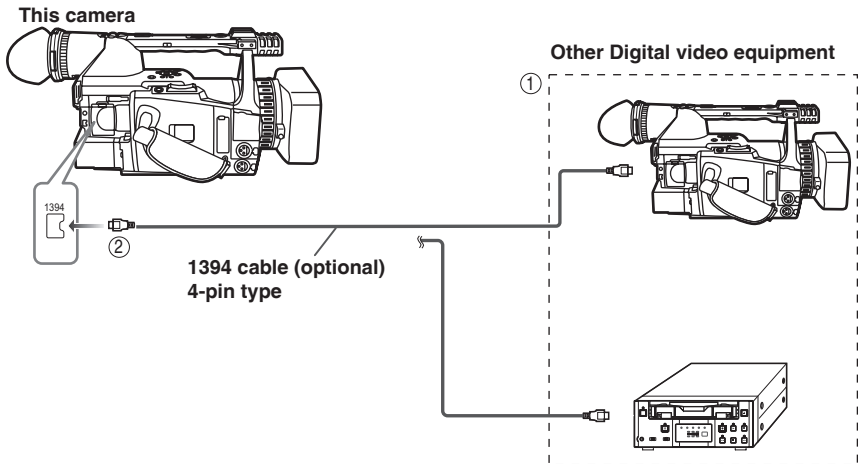

### ■ You can connect a digital video unit equipped with a DV connector and digitally transfer video and audio signals as well as time code.

- Before proceeding to connect or disconnect 1394 cable, be absolutely sure to turn off the power of the units.
- Before proceeding to connect the unit which uses a 6-pin type 1394 connector, carefully check the shape of the 1394 cable and the connectors on the 1394 cable. Connecting a connector upside down may damage the parts inside the unit and cause malfunctioning. Furthermore, connect the 1394 cable to the unit which uses a 6-pin type 1394 connector first. (① → ②)
- When recording signals from an external unit, first check that video signals are supplied.
- While signals from an external unit are being recorded, do not stop output on the external unit side or disconnect any of cables. This may lead to a failure to recognize the signals when you do recording again.
- Do not apply force when connecting 1394 cable to 1394 connector as this may damage the connector.
- No guarantees are made for the playback images when signals from an external device are recorded. (Video check level)

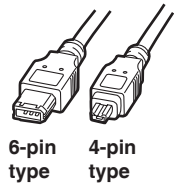

## Video deck (Dubbing)

When a component video cable is used for the connection, only the output signals from the unit will be available.

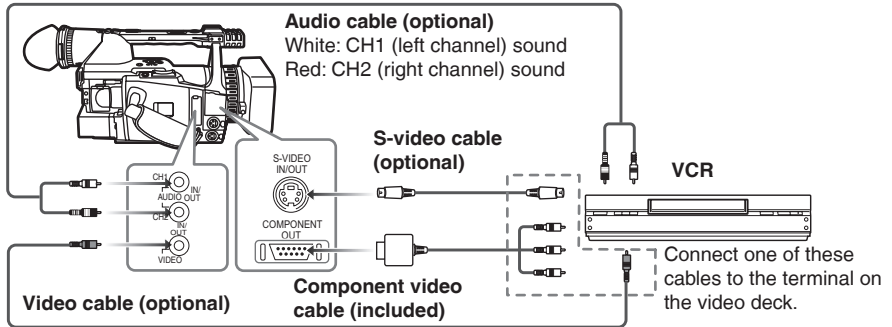

- Connect to the output terminal on the external device when the video signals and audio signals of an external device are to be input to the unit. (Tape mode only)
- Connect to the input terminal on the external device when the unit's video signals and audio signals are to be output to an external device.

- Except when performing audio dubbing on existing recordings, audio signals cannot be recorded unless video signals are input to the S-VIDEO IN/OUT connector and/or VIDEO IN/OUT jack.
- The signals of the S-VIDEO IN/OUT terminal take priority over the signals of the VIDEO IN/OUT terminal.

## TV/Monitor (playback/dubbing)

When a component video cable is used for the connection, only the output signals from the unit will be available.

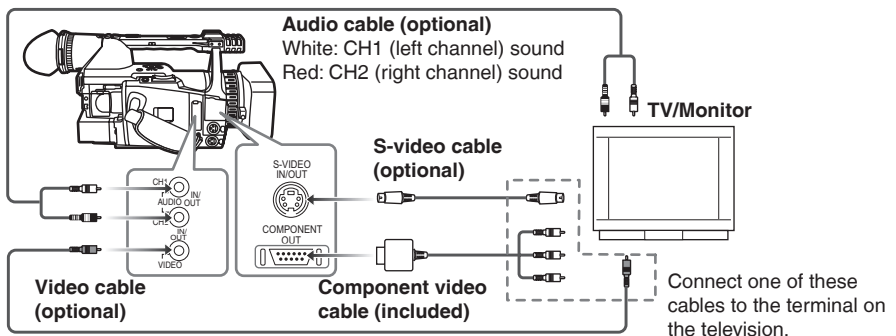

- When the COMPONENT OUT connectors and the S-VIDEO OUT or VIDEO OUT connector have been connected concurrently, the COMPONENT OUT connectors take priority. Signals cannot be output through both sets of connectors at the same time.
- When connecting the camera to another device using the component video cable, if the terminal on the device to which it is to be connected is a BNC type, use the pin-BNC conversion plug provided.

Background music or narration can be added to the images you have recorded on the tape.

**1** Set the POWER switch to ON.

**2** In the setup menus, select an audio recording system in RECORDING SETUP screen, AUDIO REC.

- For menu operation (Page 96)

**32K(12bit):**

The sound is recorded using the 12-bit/32kHz (4-channel) system.

Use this mode when you want keep the sound that recorded while you were shooting even after audio dubbing has been performed.

**48K(16bit):**

The sound is recorded using the 16-bit/48kHz (high-quality stereo) system.

When audio dubbing is performed, the sound that was recorded while you are shooting will be erased.

**3** Start shooting.

**4** Press the mode button to switch to the VCR mode.

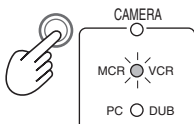

**5** In the setup menus, select an audio recording system in the AV IN/OUT SETUP screen, A. DUB INPUT.

- For menu operation (Page 96)

**MIC:**

The sound of the built-in microphone or the external unit connected to INPUT 1/2 connector is recorded. (Select by CH1 SELECT switch and CH2 SELECT switch.)

**A\_IN:**

The sound of audio component connected to AUDIO IN/OUT connector (pin jack) is recorded.

**6** Find the scene you want to add and set the unit to the still mode.

**7** Press the AUDIO DUB button to establish the status ready for audio dubbing.

Press the A. DUB button on the remote control unit.

- "A.DUB III" appears.

**8** Press the III button, input the sound and start audio dubbing.

When the III button is pressed again, the pause mode is established.

To resume audio dubbing, repeat steps 7 and 8.

- To end audio dubbing while it is underway, press the ■ button.

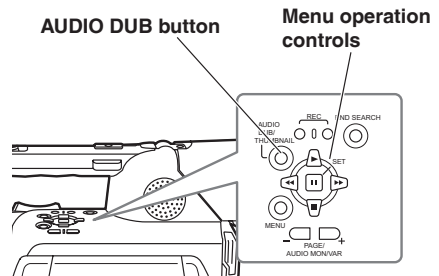



### Input channels and the tracks recorded

Input	Shooting mode	Audio dubbing mode
Built-in microphone L channel	CH1	CH3
Built-in microphone R channel	CH2	CH4
INPUT 1 (XLR)	CH1	CH3
INPUT 2 (XLR)	CH2 (CH1)	CH4 (CH3)
AUDIO IN/OUT CH1 (Pin jack)	—	CH3
AUDIO IN/OUT CH2 (Pin jack)	—	CH4

The sound track to be recorded when shooting can be changed by CH1 SELECT switch and CH2 SELECT switch.

The sound track to be recorded when dubbing can be changed at A. DUB INPUT ITEM on the AV IN/OUT SETUP screen. (Page 111)

### Adjusting the audio input level

Use the AUDIO control to adjust the recording level of audio signals input from the built-in microphone or INPUT 1/2 terminal.

- You cannot adjust the audio signals input into the AUDIO IN/OUT CH1/CH2 terminals.

### Listening to sound that has been dubbed

Switch between the sound that has been dubbed and the sound heard during shooting in the setup menus, PLAYBACK FUNCTIONS screen, 32K AUDIO. (Page 109)

#### ST1:

The sound recorded during shooting is played back.

#### ST2:

The sound that has been dubbed is played back.

#### MIX:

Both the sound recorded during shooting and that you have dubbed are played back.

### Performing audio dubbing as you listen

You can monitor the sound by setting "ST2".

If you use headphones when performing audio dubbing on a recording using microphone input, you can listen to the sound being dubbed.

When you perform audio dubbing using line input (from the audio component connected to the AUDIO IN/OUT jack), you can listen to the sound being dubbed through the speakers.

### Using the memory stop mode to edit dubbed sound

- First reset the counter memory display in the memory stop mode at the position where the audio dubbing is to end. (Page 58)
- Rewind the tape to the position where the audio dubbing is to start, and start the dubbing.
- The tape then stops automatically at the position where the counter memory display was reset.

You can edit the video data on P2 cards nonlinearly by connecting the unit to a computer used for editing by means of a USB cable (Windows) or 1394 cable (Apple Macintosh). (Connections : Page 77)

**The following conditions must be met if the USB cable is to be used to make the connection.**

- Your computer must run Windows 2000 or Windows XP.
- USB dedicated driver (provided on the CD-ROM supplied) must be installed in your computer.
- Your computer must support USB2.0 (High Speed, Mass Storage Class). (USB 1.1 is not supported.)
- Only one computer can be connected.
- No operations can be performed if a hub or other unit is connected between the unit and your computer.

Do not use a USB cable longer than 3 meters. Otherwise, malfunctions may occur.

- Operation is not guaranteed in Macintosh operating systems.

**The following conditions must be met if the 1394 cable is to be used to make the connection.**

- Your computer must run Apple MacOSX 10.3 or later.
- Your computer must support 1394.a (SBP2 protocol).
- Operation is not guaranteed in Windows operating systems.

- Insert the P2 card into the unit, and set the MEDIA switch to the P2 position. (Page 25)

**1** Set the unit's POWER switch to ON.

**2** Select PC MODE on the setting menu OTHER FUNCTIONS screen, and press the **[M]** (or **[P]**) button.

- For menu operations (Page 96)
- You can also use the menu buttons on the remote control. (Page 15)

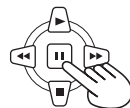
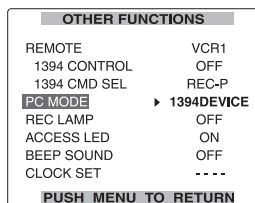

**3** Select USB DEVICE or 1394 DEVICE using the **[A]** and **[B]** buttons, and press the **[M]** button.

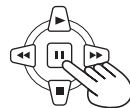
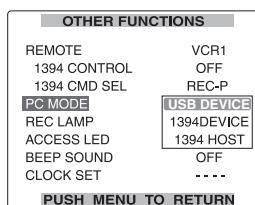

**4** Press the MENU button twice to release menu mode.



## 5 Press the mode button to light up the MCR lamp and then hold the button down (for 2 or more seconds).

The PC lamp now lights, and PC mode is established.

When the P2 card is in an accessible status, USB (or 1394) DEVICE CONNECT is displayed on the camera.

(If DISCONNECT is displayed, you cannot operate the camera.)

## 6 Proceed with nonlinear editing using your computer.

An icon for the P2 card contents appears as a removable disk in My Computer of your computer.

- For further details, refer to the instructions for your computer's editing software.
- When replacing one card with another, if the USB connection is used, check that the access lamp is not flashing and that the data on the card is not being accessed before ejecting the card. If the 1394 connection is used, place the drive icon into the computer's recycle bin before ejecting the card.
- The unit cannot be operated while in PC mode.
- When the cable is to be disconnected, proceed with "Safely Remove Hardware" on the computer.

In the case of a 1394 connection, first confirm that "1394 DEVICE DISCONNECT" is displayed on the camera-recorder before disconnecting the cable. In the case of a USB connection, "USB DEVICE CONNECT" will remain displayed so check that the card is not being accessed before disconnecting the cable.

## 7 Switch OFF the camera.

You cannot cancel the PC mode even if you press the operation mode button for an extended period.

---

**P2 cards are compliant with the Type-II standard so you can insert them straight into the computer's card slots and proceed with nonlinear editing.**

- The Card Bus driver is contained in the CD-ROM provided.
-

- Use an HDD (hard disk drive) that has sufficient capacity to permit copying.
- Before copying the data, format the hard disk drive so that it can be used by the unit. Bear in mind that this process will delete all the data on the drive.
- Connect the camera to an HDD using the 1394 cable. (Page 77)  
Do not connect the camera to two or more HDD (chain, hub, etc.), even if they are not switched ON.
- Insert the P2 card into the unit, and set the MEDIA switch to the P2 position. (Page 25)

**1 First turn on the power of the HDD (1394, a SBP2 supported) to be connected, and connect it using the IEEE1394 cable. Then turn the unit's POWER switch to ON.**

**2 Select 1394HOST for PC MODE on the setting menu OTHER FUNCTIONS screen, and press the  $\square$  button.**

- For menu operations (Page 96)

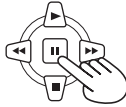
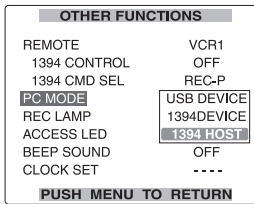

**3 Press the MENU button twice to release the menu mode.**



**4 Press the mode button to light up the MCR lamp, and then hold the button down (for 2 or more seconds).**

The PC lamp now lights, and PC mode is established.

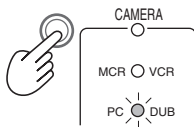

**5 Only when the hard disk drive is not formatted:**

**Select FORMAT (HDD) using the  $\Delta$  and  $\nabla$  buttons, and press the  $\square$  button.**

Then select YES using the  $\Delta$  and  $\nabla$  buttons, and press the  $\square$  button.

Formatting now starts. (Formatting is completed in about 2 to 3 seconds.)



**6 When formatting is complete:**

**Select COPY TO HDD using the  $\Delta$  and  $\nabla$  buttons, and press the  $\square$  button.**

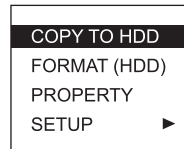

- Data is copied onto the HDD on a card by card basis.

**7 Select the card slot using the  $\Delta$  and  $\nabla$  buttons, and press the  $\square$  button.**

Then select YES using the  $\Delta$  and  $\nabla$  buttons, and press the  $\square$  button.

Copying now starts.

- You can carry out copying up to 15 times to one HDD.

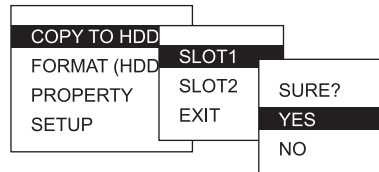



**8 When copying is complete:**



**Switch OFF the camera.**

You cannot cancel the 1394 HOST mode even if you press the operation mode button for an extended period.



### To check the data copied into the hard disk drive

After step 4 on the left, use the  and  buttons to select PROPERTY, and then press the  button.

The contents of the hard disk drive are displayed.

- To view details of the items, select an item using the  and  buttons, and press the  button.

### To verify the data when copying it into the hard disk drive

After step 4 on the left, use the  and  button to select YES from the VERIFY option on SETUP.

- Copying to the P2 card is completed, even if you interrupt processing during verification.

- 
- You cannot copy data from the hard disk drive to a P2 card.
  - Use a hard disk drive under the following conditions.
    - 1) Power is supplied from a source other than the 1394 bus. (It is not supplied from the unit.)
    - 2) You may format the hard disk drive for usage by the unit.
    - 3) Use the hard disk drive within the guaranteed operating range (humidity and other environmental conditions).
    - 4) Do not place the hard disk drive in an unstable locations or locations subjected to vibrations.
  - Some HDD may not operate correctly.
  - During formatting or copying, do not remove any cables, eject the P2 card, or turn off the power for the unit or hard disk drive. The power will need to be turned on again.
  - No guarantees are made for operation if the 1394HOST mode is established without first connecting the HDD (1394.a SBP2 supported) and then the HDD is connected. In this case, turn off the power, and then release the 1394HOST mode.
  - **The hard disk drive is an extremely high-precision device. Therefore, it is highly possible that data cannot be read in certain operating environments.**  
Please note that our company will not be liable for any data losses due to hard disk drive failure or other faults, or any other direct or indirect damage related to these problems.
  - **If you rewrite the contents of the HDD used to carry out copying from the camera to another PC, the subsequent operation in the camera and the data in the HDD cannot be guaranteed.**

- It is recommended that you first restore any defective clips contained in the P2 card before copying the data.
- In order to avoid the occurrence of trouble in copying, formatting or other operations, it is recommended that you perform these operations after ensuring that power supply has stabilized.

## Warnings

### HDD CAPACITY FULL!

There is not enough free memory on the HDD.

### TOO MANY PARTITIONS!

There are too many partitions.

### HDD DISCONNECTED!

The HDD has been disconnected.

### CANNOT INITIALIZE!

Initializing cannot be performed.

### TOO MANY TARGETS!

There are too many 1394 connection destinations.

### CANNOT ACCESS TARGET!

The connection destination cannot be accessed.

### CANNOT ACCESS CARD!

The card cannot be accessed.

### MISMATCH COMPONENT!

There is a mismatch with the connection destination.

### UNKNOWN DEVICE CONNECTED!

A device other than an HDD has been connected.

### P2 CARD IS UNFORMATTED!

The P2 card is still unformatted.

### CARD IS EMPTY! CANNOT COPY!

There is no data on the P2 card and so it cannot be copied.

### VERIFICATION FAILED!

A mismatch was discovered by verification.

### TURN POWER OFF!

Turn off the power.

### CANNOT RECOGNIZE HDD!

HDD recognition failed.

# Dubbing

## Dubbing the contents of P2 cards onto a tape (dubbing mode)

You can dub any clips from a P2 card to a tape that you have inserted into the unit.

The recording formats of clips that can be dubbed are all of the 1080i and 720P formats. In all cases, the data is recorded in the DV format.

- Check to see if the tape is in a write-protected state. (During the dubbing operation, an error message does not appear.)
- Insert the P2 card and tape into the unit, and set the MEDIA switch to the TAPE position. (Pages 25 and 29)

**1** Set the unit's POWER switch to ON.

**2** Press the mode button to light up the VCR lamp.

**3** Move the tape forward to the position to start recording.

- It is convenient to use the End Search (page 74) function.

**4** Hold down the mode button (at least 2 seconds).

The DUB lamp now lights, and dubbing mode is established.

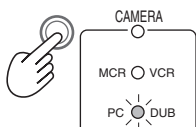

The clips on the P2 card appear as thumbnails on the LCD screen.

**To set the formats that permit dubbing**

- 1) Press the THUMBNAIL button to close the thumbnail display, and use the MENU button to open the menu.
- 2) Select DUBBING SETUP and then FORMAT SEL to select the format. Select the same format as the recording format shown at the bottom left of the thumbnail display.
- 3) Use the MENU button to close the menu, and press the THUMBNAIL button to return to the thumbnail display.

Clips with formats that permit dubbing are indicated by black numbers; all other clips are indicated by the red numbers. (Clips indicated by the red numbers cannot be dubbed.)

**To perform the pulldown setting when dubbing 720/24PN format clips**

- 1) Press the THUMBNAIL button to close the thumbnail display, and use the MENU button to open the menu.
- 2) Select DUBBING SETUP and then PULLDOWN SEL. Select 24P or 24PN.  
24P: 2:3 pulldown  
24PN: 2:3:3:2 pulldown
- 3) Use the MENU button to close the menu, and press the THUMBNAIL button to return to the thumbnail display.

**5** Select the first clip to be dubbed using the ◀ and ▶ buttons, and press the ■ button.

You can select multiple clips by repeating the above procedure. Upon completing the selection, switch to the SELECTED CLIPS display on the THUMBNAIL menu, and check that the cursor appears at the first clip on the thumbnail display.

**To dub all the clips in the format selected in step 4**

Position the cursor at the first valid clip (indicated by the black number) on the thumbnail display.

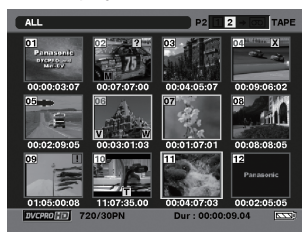

- Dubbing will start from the clip where the cursor is positioned so check the position of the cursor before proceeding.
- Dubbing will not start if the cursor is positioned on a clip indicated by a red number.

**6** Press the two REC buttons simultaneously.

If you are using the remote control, press the PLAY button while holding down the REC button.

Dubbing now starts. When it finishes, it will automatically stop, and the thumbnail display will be restored. (To stop dubbing while it is underway, press the ■ button.)

- When you wish to start dubbing from a point mid-way along a clip, first play back the clip, then press the **III** button at the desired position to pause playback.

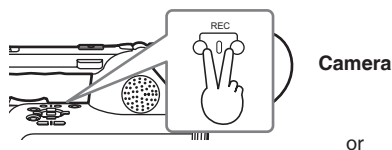

or



## 7 Hold down the mode button (for 2 or more seconds) to release dubbing mode.

- In the VCR setting menu, setting the TCG option in RECORDING SETUP to FREE RUN enables the timecode used by the clip to be transferred to the tape.
- In the case of a clip recorded in four channels, the audio of channels 3 and 4 will not be transferred during the dubbing process.
- The dubbing IN points may be slightly ahead of or behind their actual positions.
- In the case of clips recorded continuously onto three or more cards, dub the clips on two of the cards first. After this, stop the dubbing, and replace the cards with the third and subsequent cards. Then resume the dubbing. (These steps are taken because hot swap playback cannot be performed.)
- In the dubbing mode, even if an attempt is made to allocate SHOT MARK, INDEX/MEMO or SLOT SEL to a USER button, the allocated operation will not be executed. However, the allocated USER button information will be displayed when the DISP/MODE CHK button is held down.

## Digital input/output (P2 card/Tape)

You can perform dubbing with a high image quality by means of digital signals by using a 1394 cable to connect this unit to a digital video unit equipped with a 1394 connector.

- Use the MEDIA switch to select the P2 card or tape ahead of time. (Pages 25 and 29)

## 1 Connect the digital video equipment to this unit. (Page 78)

## 2 Press the unit's mode button to switch to the MCR/VCR mode.

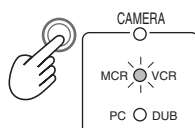

- Cancel the thumbnail screen when in MCR mode.
- Set up the connected equipment for playback or recording.
- When performing digital dubbing with a second camera-recorder or other device, a recording cannot be made unless the signal formats at the output side and input side are identical.
- When using with the 720P/24PN and 720P/30PN settings, digital output in MCR mode only is performed. Digital input is not possible.
- 1394 input images cannot be output from the COMPONENT OUT terminal.

## 3 Start playing back in the player.

## 4 Start recording in the recorder.

- If you are using this unit, press the two REC buttons at the same time. On the remote control unit, press the PLAY button while holding down the REC button.

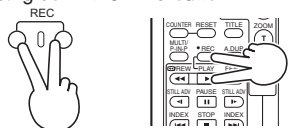

Camera or Remote control

- In the VCR mode, the recording standby status is established when these two buttons are pressed together in the playback pause status. (The recording standby status will not be established in the MCR mode.) Each time you press the **III** button, the status switches between recording and recording standby.

## 5 Stop recording in the recorder.

- On this unit, press the **■** button.

## 6 Stop playback on the other unit.

- On this unit, press the **■** button.

## Dubbing (continued)

---

- In the case of tape, the audio when you perform digital dubbing will be recorded in the same audio mode as that on the playback side, regardless of the menu setting on the recording side.

In the case of the P2 card, the DV format is converted into 48K 2CH or 4CH. In the case of 1080i and 720P, channels 1 to 4 are recorded directly, and channels 5 to 8 are not recorded.

- If you have set 1394TC REGEN or 1394UB REGEN to on in the recording unit's menus you can copy the time code and user information from the playback source. (Pages 107 and 108)

Do not start recording until you can see the images on the recording unit's screen. Time code and user information may not be correctly recorded if you start recording before the images are received.

---

### Analog output (P2 card/Tape)

You can record images you have shot on this unit to an S-VHS (VHS) tape in a video deck.

- Use the MEDIA switch to select the P2 card or tape ahead of time. (Pages 25 and 29)

**1** Connect the video recording device to the unit. (Page 79)

**2** Press the mode button to switch to the MCR/VCR mode.

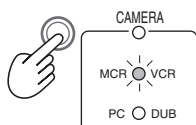

**3** Set the unit to playback.

**4** Start the recording by operating the video recording device.

When video recording is completed, stop the video recording device.

To stop playback, press the **■** button.



**Analog input (Tape)**

Video contents on S-VHS (VHS) cassettes can be copied to tape, and TV programs can be recorded.

- Set the MEDIA switch to the TAPE position. (Page 29)

**1** Connect this unit to a video deck or a television. (Page 79)

**2** Press the mode button on the unit to switch to the MCR/VCR mode.

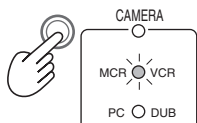

**3** Set the external device to playback.

**4** Press the two REC buttons simultaneously. On the remote control, while pressing the REC button, press the PLAY button.

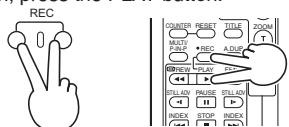

**Camera or Remote control**

- When you press these two buttons simultaneously in the playback pause status, the unit is set to recording standby status. Each time you press the **|||** button, the status switches between recording and recording standby.

To stop the dubbing, press the **■** button.

- Stop playback on the external unit.

- You cannot adjust the audio level.
- Analog signals cannot be input in the P2 mode.

**Analog/digital (AD) conversion (VCR mode only)**

You can use this unit to convert analog to digital signals. In the setup menus, AV IN/OUT SETUP screen, set 1394 OUT to "ON". (Page 111)

This enables you to output digital images, which were input as analog signals from an external unit, through this unit's 1394 connector to another digital video unit.

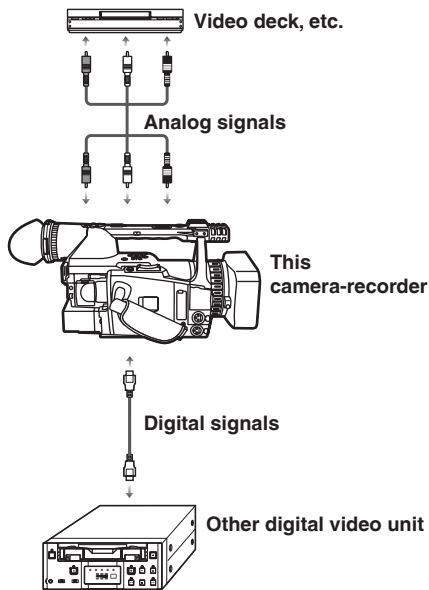

- Normally, set 1394 OUT to "OFF". Images may be disrupted if you set it to "ON".
- You can also use the S-video cable.

# Screen displays

## Regular displays

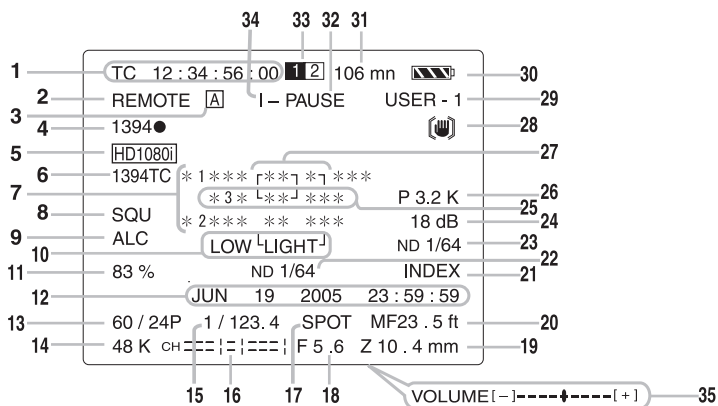

### 1 Time code displays

Each time you press the COUNTER button, the display switches over to the following data (or no indication).

**COUNTER:** (Tape or P2-camera mode only)

Counter value

**M COUNTER:** (Tape only)

Counter value in memory stop mode

**TC:**

Time code value. When the time code value could not be read correctly from the tape, [TC\*] is displayed.

When it acts in drop frame mode, the colon between seconds and frames become “.”.

**UB:**

User information

When user information could not be read correctly from the tape, [UB\*] is displayed.

**FR:**

Frame rate information for recording

FR 60i : Standard (60i interlace) mode (60 fields/sec.)

FR 60P : 60P progressive mode (60 frames/sec.)

FR 30P : 30P progressive mode (30 frames/sec.)

FR 24P : 24P progressive mode (24 frames/sec.)

FR 24PA : 24P advanced mode

When in FR24P and FR 24PA mode, the sequence information of the frame conversion at the final place.

### 2 Warnings

**REMOTE:**

Blinks when the wrong equipment setting is selected on the remote control unit.

 :

Lights when condensation has formed inside the camera-recorder.

 :

Blinks when cylinder heads are dirty.

 or  :

Blinks when a P2 card or tape has not been inserted, or when the camera is in a write-protected state.

 **FULL** or  **END:**

Blinks when either there is no remaining capacity in the P2 card or the tape has reached the end.

 **LACK:**

Blinks in the loop rec mode when the remaining capacity of the P2 card is insufficient.

 :

Lights when the internal battery for the calendar has run out.

### 3 AUTO/MANUAL switch operation display

This display appears if a function which has been set on the setting menu AUTO SW screen is operating when the AUTO/MANUAL switch has been pressed.

#### 4 Backup unit displays

The status of the backup unit connected to the 1394 connector is displayed here.

Nothing is displayed if in the setup menus, OTHER FUNCTIONS screen, 1394 CONTROL, you have selected "OFF".

1394 ●: Recording

1394 III: Recording standby

1394 ☒: The backup unit cannot be controlled.

1394 : The backup unit is not connected.

1394 - -: The backup unit is connected but is in a mode other than recording or recording standby.

#### 5 Recording format (P2 card) (Page 106)/ recording time (tape) display

#### 6 1394TC display

Appears when the 1394 IN PRESET option on the setting menu RECORDING SETUP screen is ON. However, it does not appear when the FIRST REC TC item is REGEN. (This appears in the MCR/VCR mode.)

#### 7 Information display

Following information is displayed depending on the situation.

- Performance of the auto white balance or the auto black balance
- Warning (Page 94)
- The functions allocated to the USER buttons are displayed while you hold down the DISP/MODE CHK button.

#### 8 Squeeze information

Appears when in the setup menus, CAMERA SETUP screen, ASPECT CONV, you have selected "SQUEEZE" (page 102) or when playing back images recorded in the squeeze mode.

#### 9 Mic level auto control

Appears when in the setup menus, RECORDING SETUP screen, MIC ALC, you have selected "ON".

#### 10 AWB error

##### LOWLIGHT:

Appears when the brightness level adjusted by the auto white balance is too low.

#### 11 Marker luminance display

When markers are displayed, the brightness level around the center of the screen is indicated as 0% to 99%. "99%1" appears if the percentage is over 99.

#### 12 Calendar

##### Month:

JAN (January), FEB (February), MAR (March), APR (April), MAY (May), JUN (June), JUL (July), AUG (August), SEP (September), OCT (October), NOV (November), DEC (December)

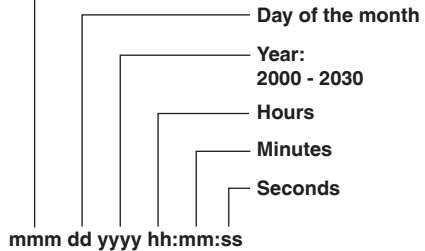

#### 13 Recording/playback frame rate display

Apart from the case of 720/30PN and 720/24PN, only the recording frame rate is displayed.

#### 14 Audio sampling frequency (Tape only)

#### 15 Shutter speed

The shutter speed is displayed here.

#### 16 Audio level meter (Page 53)

#### 17 Auto iris control displays

**STD** : Standard auto-iris control

**SPOT** : Auto iris control for spotlight

**BACK** : Auto iris control for backlight compensation

#### 18 IRIS display

Displays F value.

The F value during shooting is also displayed during playback when ON was selected under CAMERA DATA of the setting menu DISPLAY SETUP screen.

#### 19 Zoom position display



























The zoom position is displayed with Z00 (maximum wide-angle) - Z99 (maximum zoom). The unit can be switched to mm in the ZOOM•FOCUS option of the setting menu DISPLAY SETUP screen.

#### 20 Focus control display

Displays the focus control information with 99-00.

In the auto focus mode, AF appears. In the manual focus mode, MF appears. When the display is set to macro control, the black and white of AF or MF are displayed in reverse.

## Screen displays (continued)

- 95** (Focal distance: infinity)  
:  
**00** (Focal distance: approx. 5 cm)  
Depending on the zoom position, the macro range may not be enabled. Also, depending on the zoom position, the lower limit value of macro range may be different.  
The units can be switched between feet and m in the ZOOM•FOCUS option of the setting menu DISPLAY SETUP screen.
- 21 INDEX/MEMO/MARK IN recording display**  
This display lights when the USER button to which the INDEX/MEMO function has already been allocated is pressed while recording and the index/memo signals are recorded.  
It blinks when the USER button is pressed before recording. (Index/memo signal recording standby status)
- 22 Recommended ND filter**  
The recommended ND filter under the current shooting conditions is displayed here.
- 23 ND filter display**  
ND filter selected is displayed.  
When [ND--] is displayed, the ND filter may be out of alignment. (OFF, the position except 1/8, 1/64)  
Check the position of the ND filter switch.
- 24 Gain display**  
Displays the gain value of the image amplifier configured. (During the auto mode, AGC is displayed.)  
When the CAMERA DATA option on the setting menu DISPLAY SETUP screen is set to ON, the value of the gain used during shooting is also displayed during playback using tape.
- 25 AWB operation display**  
The white balance operation is indicated here.
- 26 AWB information display**  
Displays the information of white balance.  
**ATW:** When ATW is set  
**P3.2K/P5.6K:** In the case of preset  
**Ach/Bch:** In the case of A/B  
**LOCK:** When ATW is locked
- 27 Displays marker**  
During shooting, pressing the ZEBRA button once or twice will display the marker.
- 28 Optical Image Stabilizer (  ) display**  
 also appears during tape playback as camera data when images were shot in the optical image stabilization mode if ON was selected under CAMERA DATA of the setting menu DISPLAY SETUP screen.
- 29 Scene file name display (in camera mode)/ DUB display (in dubbing mode)** (Pages 54 and 86)
- 30 Remaining battery charge**  
As the remaining battery charge drops, the display changes as follows:  →  →  →  →  →   
When the battery has completely discharged,  (  ) blinks.  
(When the AC adapter is being used, a display other than  may appear: this is not a sign of malfunctioning.)
- 31 Media remaining memory display**  
There is no display while the remaining memory is being calculated. Also, the remaining memory is not displayed during slow playback using tape. "LOOP" is displayed during Loop recording (LOOP REC).
- 32 Operational state display**  
**REC :** Recording  
**PAUSE :** Recording pause  
 : Play pause  
**STNDBY :**  
Standby (the cylinder-head is stopped)  
**A. DUB  :**  
Standby for dubbing record  
**A. DUB  :**  
Dubbing record  
 : Play  
 (  ) :  
Fast-forward/Fast-forward play  
(Rewind/Fast-backward play)  
 (  ) :  
Slow play (Reverse slow play)  
**CHK :** Rec check  
 (  ) :  
Cue (reverse cue)  
 (  ) :  
Frame-by-frame (Reverse Frame-by-frame)  
**BLANK :**  
Blank search  
**REC END :**  
End of recording search  
**x  /x  ( x  /x  ):**  
Variable-speed search (Reverse variable-speed search)

### 33 Media information display

The card slot where the P2 card was inserted and the basic information of the media are displayed here.

**[1][2] lights:**

P2 card on which data can be recorded.

**[1][2] lights green:**

P2 card on which data is to be recorded.

**[1][2] flashes:**

Card recognition underway.

**[ ] [ ] :**

No card inserted.

**P:** Write-protected

**F:** Full memory

**X:** Cannot recognize

### 34 Special recording display

This display appears when the REC FUNCTION option of the setting menu RECORDING SETUP screen is set to INTERVAL, ONE SHOT or LOOP, and when PRE REC is set to ON.

### 35 Monitor sound volume level meter

When you press the PAGE/AUDIO MON/VAR button, the sound volume output from the built-in speaker and PHONE jack is displayed.

## Warnings

### COPY INHIBITED

Can not record correctly because of the input signal copy-guarded.

### EXTERNAL 1394 DISCONNECT

When the 1394 CONTROL item of the OTHER FUNCTIONS screen of the Setup menu is set to EXT and recording without connecting external units with 1394 terminal, this display appears.

### INCOMPATIBLE CARD

The card cannot be used since it does not comply with the specified standard.

### INCOMPATIBLE TAPE

Can not use because the tape is not the standard for this unit (e.g. a tape for saving data).

### LOW BATTERY

No operations can be performed since the battery charge is low.

### UNPLAYABLE TAPE (OTHER FORMAT)

Can not playback because of the different tape format.

### UNABLE TO A. DUB (LP RECORDED)

Can not perform dubbing because the tape was recorded with LP mode.

### <Thumbnail operations>

#### CANNOT ACCESS

Cannot access clips.

#### CANNOT DELETE

Cannot delete clips.

#### CANNOT FORMAT

Cannot format P2 cards or SD memory cards.

#### CANNOT REPAIR

 Cannot repair clips.

#### CARD FULL

The P2 card does not have enough free space for recording.

#### WRITE PROTECTED

The P2 card or SD memory card is write-protected.

#### NO CARD

A P2 card or SD memory card has not been inserted.

#### NO FILE

There are no files (version upgrade files, etc.).

## Screen displays (continued)

---

### Errors

These are displayed when an error occurs in the unit, P2 card, tape, or other component. If the problem is not fixed by turning the power off and then on again, either replace the card or tape based on the error information, or contact your nearest service center.

#### **AUTO OFF**

When trouble occurs with tape running systems, AUTO OFF is displayed.

When AUTO OFF is displayed, the power supply of this device is automatically set to OFF.

#### **CYLINDER LOCK**

#### **LOADING LOCK**

#### **UNLOADING LOCK**

**T REEL LOCK** (Take up reel lock)

**S REEL LOCK** (Supply reel lock)

#### **CANNOT PLAY**

This is displayed when trouble has occurred during playback.

#### **CARD ERR (1) (2) (1/2)**

(Trouble has occurred in the P2 card found in the slot indicated by the number.)

**CLIP ERROR** (clip trouble)

**ERROR** (other type of trouble)

#### **SYSTEM ERROR**

This is displayed when trouble has occurred in the system. Switch ON the power again.

**P2 MICON ERROR** (no P2 microcomputer response)

**P2 CONTROL ERROR** (trouble in P2 control)

**REC RAM OVERFLOW** (recording RAM overflow)

#### **TURN POWER OFF**

This display appears when an abnormality occurs as a result of the card being pulled out while data is being accessed.

#### **REC WARNING**

This is displayed when trouble has occurred during recording. Carry out recording once again. If the warning persists, consult your dealer.

#### **CARD ERR (1) (2) (1/2)**

(Trouble has occurred in the P2 card found in the slot indicated by the number.)

- If the warning continues, turn off the power.
- If the warning appears even when recording is carried out again, replace the card with another one.

**ERROR** (other type of trouble)

#### **WARNING**

When trouble occurs with camera systems, WARNING is displayed.

**FOCUS LOCK** (Abnormal focus operation)

**PSD NG** (Abnormal vibration detected)

**GYRO NG** (Abnormal Optical Image Stabilizer control)

#### **1394**

This is displayed when trouble has occurred in the 1394 connections or signals. (P2 mode only)

**1394 INITIAL ERROR** (connection error)

**1394 INPUT ERROR** (input error)

**1394 INPUT ERROR (OTHER FORMAT)** (wrong input format)

## Setting the DISPLAY items

Display the following items on the viewfinder and LCD monitor screen by pressing the DISP/MODE CHK button or by configuring OTHER DISPLAY of the DISPLAY SETUP screen of the setup menus. (Page 113)

Displays	MODE CHECK	DISPLAY	Audio dubbing mode		
			ALL	PARTIAL	OFF
1 Counter display	✓	—	—	—	—
3 AUTO/MANUAL switch operation display	✓	✓	✓	✓	x
5 Recording format display	✓	✓	✓	x	x
7 Displaying the function allocated to the USER button	✓	—	x	x	x
8 Squeeze record display	✓	✓	✓	✓	x
9 Microphone level auto-control display	✓	✓	✓	x	x
12 Date and time display	✓	✓	—	—	—
13 Recording/playback frame rate display	✓	✓	✓*1	x	x
14 Audio-sampling frequency display	✓	✓	✓	x	x
15 Shutter speed display	✓	✓	✓	✓	x
16 Audio level meter display	✓	✓	—	—	—
17 Auto-IRIS control display	✓	✓	✓	✓	x
18 IRIS display	✓	✓	✓	✓	x
19 Zoom position display	✓	✓	—	—	—
20 Focus control display	✓	✓	—	—	—
22 Recommended ND filter display	✓	✓	✓	✓	x
23 ND filter display	✓	✓	✓	x	x
24 Gain display	✓	✓	✓	✓*2	x
26 AWB information display	✓	✓	✓	✓*3	x
28 Optical Image Stabilizer display	✓	✓	✓	✓	x
29 Scene file name display	✓	✓	✓	x	x
30 Remaining battery display	✓	✓	—	—	—
31 Media remaining memory display	✓	✓	—	—	—

✓ : Displayed

x : Not displayed

— : Displayed depending on other settings

The item in ✓ in the MODE CHECK space appears when you press and hold the DISP/MODE CHK button. The item in ✓ in the DISPLAY space disappears when you press the DISP/MODE CHK button.

\*1 Not displayed when FRAME RATE is set to 60i.

\*2 0 dB is not displayed.

\*3 Only preset 3.2K and 5.6K are displayed.

# Using the setup menus

Use the setup menus to change the settings to suit the scenes you are shooting or what you are recording.

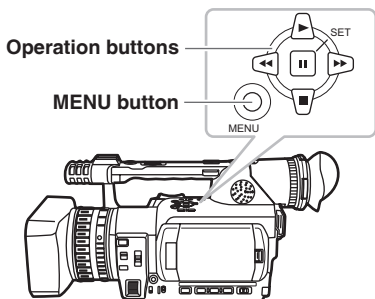

## Using the menus

If the thumbnail menu is displayed, press the AUDIO/THUMBNAIL button to release the display. (Page 66)

- 1 When the unit is in other than playback or recording mode, press the MENU button. The following is displayed on the viewfinder and LCD screen.

### CAMERA mode (Example)

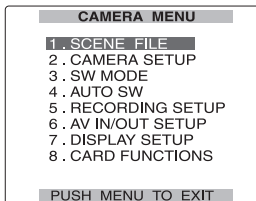

### MCR/VCR mode (Example)

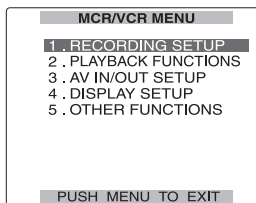

- 2 Press  $\Delta$ ,  $\nabla$  to highlight the function you want to change.

- 3 Press the  $\square$  (or  $\triangleright$ ) button to display the items.

### Example:

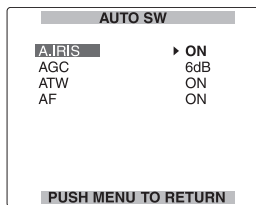

- 4 Use the  $\Delta$  and  $\nabla$  buttons to move to the option that you want to set.

### Example:

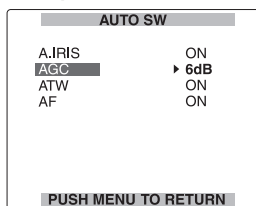

- 5 Press the  $\square$  button to make the setting. To change a number, use the  $\Delta$  and  $\nabla$  buttons to change the setting value.

### Example:

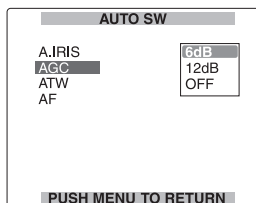



---

**6 To change other settings, repeat steps 4 and 5.**

When you finish, press the MENU button to return to the function screen.

**7 To change other functions, repeat steps 2 to 5.**

When you exit the menu mode, press the MENU button again to return to the normal screen.

### Initializing the menu settings

The menu settings contain both the user file settings and the scene file settings. You can initialize them separately.

**To initialize the user file (i.e. all the settings other than the scene file settings)**

Select INITIAL in USER FILE of the OTHER FUNCTIONS screen. The current menu settings of user file will return to the factory settings.

**To initialize the scene file**

From the 6 scene files, select the one you want to initialize with the scene dial. Then in the SCENE FILE screen, SAVE/INT, select INITIAL. The settings for only the selected scene file are returned to the factory settings.

- This does not effect the other scene files.

# Setup menu structure

## Camera mode menu

**P2** **TAPE** indicates the available setting in P2 mode only or TAPE mode only.

### CAMERA MENU

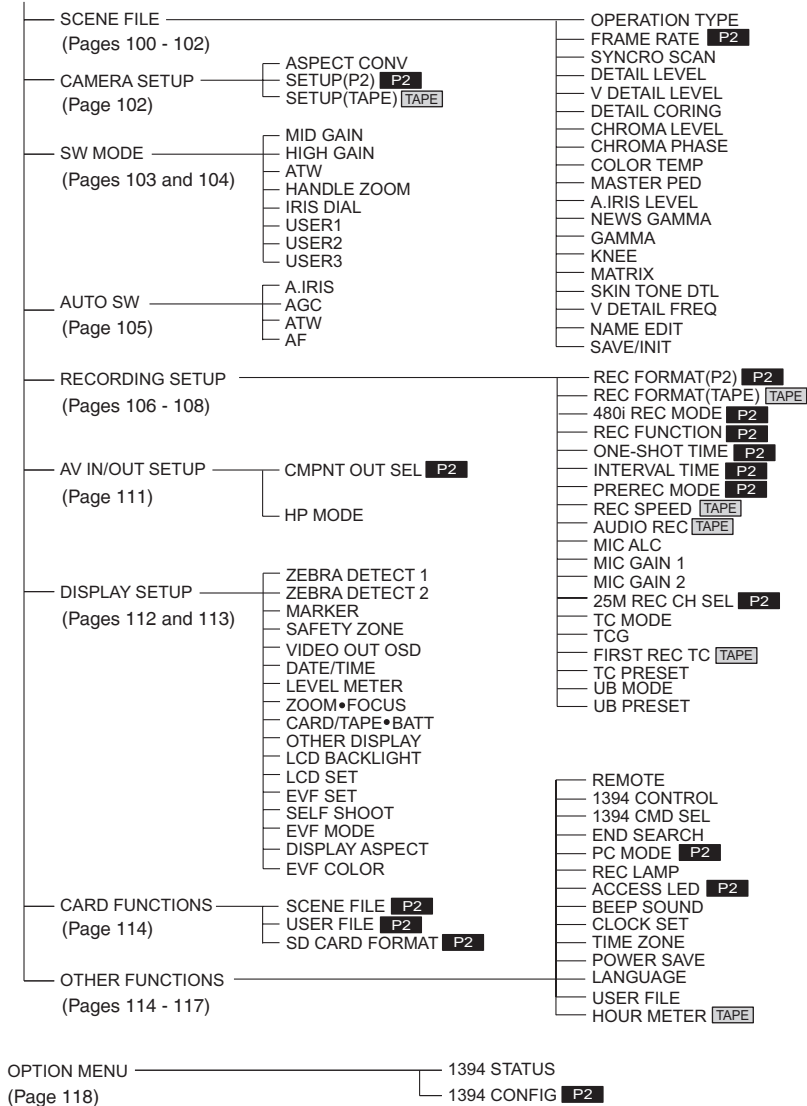

## MCR/VCR (playback and external input) mode menu

**P2** **TAPE** indicates the available setting in P2 mode only or TAPE mode only.

### MCR/VCR MENU

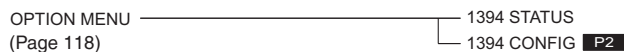
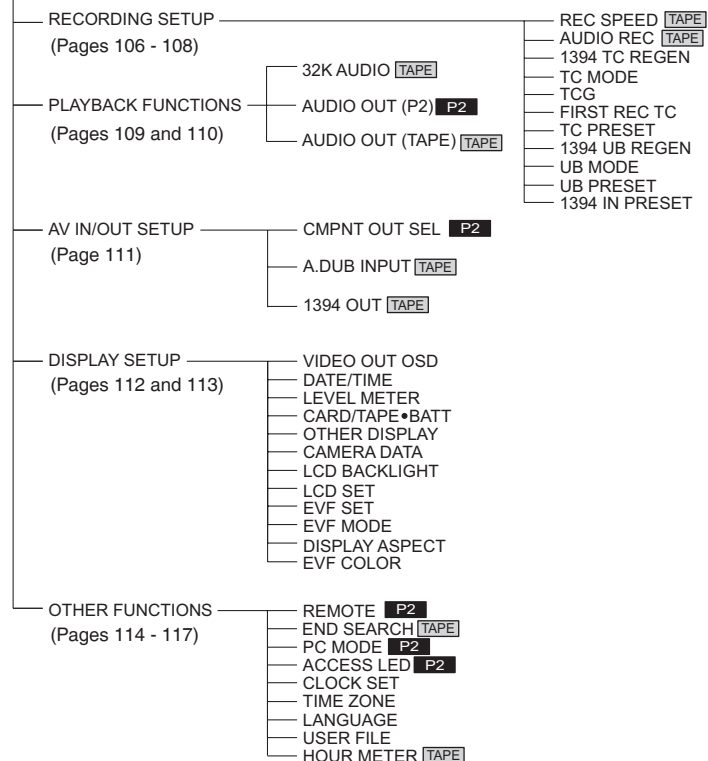

## Dubbing mode menu

This screen appears only in the dubbing mode.

### DUBBING MENU

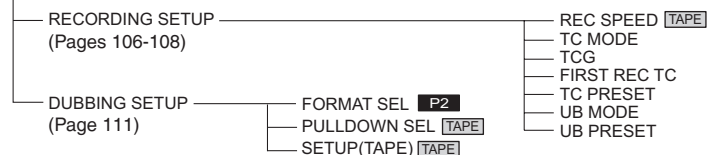

# Setup menu list

SCENE FILE screen		
Item	Display mode	Description of settings
<b>OPERATION TYPE</b> P2 TAPE	(Camera)	Switches the shutter and frame rate operation to the video type or film type. <b>VIDEO CAM:</b> SYNCRO SCAN is displayed using 1/n units. The frame digits of the time code are displayed for 30 frames. • These digits are displayed for 24 frames when 720P/24PN is selected for the REC FORMAT (P2) option (page 106) on the RECORDING SETUP screen. <b>FILM CAM:</b> SYNCRO SCAN is displayed as an angle. The frame digits of the time code are displayed for 24 frames.
<b>FRAME RATE</b> P2	(Camera)	Selects the shooting interval and exposure time when 720P and FILM CAM is selected. The DEFAULT value is dependent on the frame rate of the recording format. <b>DEFAULT, 12, 18, 20, 22, 24, 26, 30, 32, 36, 48, 60 FRAME:</b>
<b>SYNCRO SCAN</b> P2 TAPE	(Camera)	Adjusts the synchro scan shutter speed used for shooting images on a TV screen, etc. Press and hold the operation button to $\Delta$ or $\square$ to speed up the value changing. When VIDEO CAM is selected as the OPERATION TYPE option setting: • <b>60P/60i:</b> 1/60.0...1/249.8 • <b>30P/30PN:</b> 1/30.0 ...1/48.0 ...1/249.8 • <b>24P/24PA/24PN:</b> 1/24.0 ...1/48.0 ...1/249.8 When FILM CAM is selected as the OPERATION TYPE option setting: The shutter speed is displayed as an angle such as "180.0d." 10.0 deg ... 180.0 deg ... 350.0 deg (the angle can be changed in increments of 0.5 degrees)
<b>DETAIL LEVEL</b> P2 TAPE	(Camera)	Adjusts the level of the image outline correction (in the horizontal and vertical directions). -7...0...+7
<b>V DETAIL LEVEL</b> P2 TAPE	(Camera)	Adjusts the level of outline correction in the vertical direction. -7...0...+7
<b>DETAIL CORING</b> P2 TAPE	(Camera)	Adjusts the level of noise reduction of the detail signal. -2...0...+7 Set to - for a clearer image. Noise increases slightly. Set to + to reduce noise.
<b>CHROMA LEVEL</b> P2 TAPE	(Camera)	Adjusts the chroma level. -7...0...+7
<b>CHROMA PHASE</b> P2 TAPE	(Camera)	Makes fine adjustments to the chroma phase. -7...0...+7
<b>COLOR TEMP</b> P2 TAPE	(Camera)	Makes fine adjustments to the color temperature (after white balance adjustment). -7...0...+7
<b>MASTER PED</b> P2 TAPE	(Camera)	Adjusts the master pedestal (black level of the image) as the basis for images. -15...0...+15
<b>A. IRIS LEVEL</b> P2 TAPE	(Camera)	Sets the desired AUTO IRIS level. -4...0...+4
<b>NEWS GAMMA</b> P2 TAPE	(Camera)	Selects the news gamma curve. <b>ON OFF</b>

\_\_\_ indicates the factory setting.

## SCENE FILE screen (continued)

Item	Display mode	Description of settings
<b>GAMMA</b> <b>P2</b> <b>TAPE</b>	(Camera)	Selects the gamma curves other than the news gamma curve. <b>HD NORM:</b> This gamma setting is suitable for HD shooting. <b>LOW:</b> Makes a mellow image using the gamma curve which has a gentle incline in low-brightness curve. The contrast sharpens. <b>SD NORM:</b> This is the normal video setting, carried over from the DVX100 series. <b>HIGH:</b> Expands the tone of dark parts and makes a brighter image using the gamma curve which has a sharp incline in low-brightness curve. The contrast softens. <b>B.PRESS:</b> Makes the contrast shaper than LOW. <b>CINE-LIKE_D:</b> Makes a cinema-like image. <b>CINE-LIKE_V:</b> Makes a cinema-like image with emphasized contrast. When you select CINE-LIKE gamma, we recommend to set the lens aperture lower than normal image level (approximately 1/2) to enjoy the full benefit of the function.
<b>KNEE</b> <b>P2</b> <b>TAPE</b>	(Camera)	To avoid overexposure, select the compression level (knee point) of the high intensity video signals received through CCD. <b>AUTO:</b> Sets the level automatically according to the received signals. <b>LOW:</b> Low setting (Compression starts at approx. 80%). <b>MID:</b> Medium setting (Compression starts at approx. 90%). <b>HIGH:</b> High Setting (Compression starts at approx. 100%).
<b>MATRIX</b> <b>P2</b> <b>TAPE</b>	(Camera)	Selects the MATRIX table suitable for the desired color expression during shooting. <b>NORM:</b> Suitable for shooting in the open air or under a halogen lamp. <b>ENRICHED:</b> Suitable for brighter colors than the NORM mode. <b>FLUO:</b> Suitable for shooting under fluorescent light indoors. <b>CINE-LIKE:</b> Suitable for cinema-like image.

\_\_\_ indicates the factory setting.

## Setup menu list (continued)

### SCENE FILE screen (continued)

Item	Display mode	Description of settings
<b>SKIN TONE DTL</b> P2 TAPE	(Camera)	Sets the skin tone details. Select ON to reduce the skin tone details and soften the skin tone. <b>ON OFF</b>
<b>V DETAIL FREQ</b> P2 TAPE	(Camera)	Sets the vertical detail for shooting in 480i progressive mode. <b>THIN</b> : Makes the detail thin. <b>MID</b> : Makes the detail slightly thicker. <b>THICK</b> : Makes the detail thicker. When images were shot in the progressive mode in which the vertical detail is set as "THIN" or "MID" and are played on a monitoring television (60i interlace), you will see flickers caused on horizontal lines and almost horizontal oblique lines. When playing back images in the progressive mode or when editing images or performing other postprocessing, images with a higher resolution will be obtained with the THIN or MID setting than with the THICK setting.
<b>NAME EDIT</b> P2 TAPE	(Camera)	Edits the name of the selected scene file you have selected with the scene file dial.
<b>SAVE/INIT</b> P2 TAPE	(Camera)	<b>SAVE:</b> Saves the changed scene file settings. • The settings will not be saved if you exit the menu mode, switch to the MCR/VCR mode or turn the camera off without selecting SAVE. <b>INITIAL:</b> The settings of the scene file selected with the scene file dial are returned to the factory settings.

### CAMERA SETUP screen

Item	Display mode	Description of settings
<b>ASPECT CONV</b> P2 TAPE	(Camera)	Selects the aspect ratio of the image you record in 480i format. This item cannot be selected when the 1080i or 720P recording format is used. (Page 44) <b>NORMAL</b> <b>LETTER BOX</b> <b>SQUEEZE</b>
<b>SETUP (P2)</b> P2	(Camera)	Switch the setup level of video signals in 480i format using a P2 card. <b>0%:</b> Setup is switched to 0% for both the camera output and the recording. <b>7.5%A:</b> Setup is switched to 7.5% for the camera output and 0% for the recording.
<b>SETUP (TAPE)</b> TAPE	(Camera)	Switch the setup level of video signals in 480i format using a tape. <b>0%:</b> Setup is switched to 0% for both the camera output and the recording. <b>7.5%:</b> Setup is switched to 7.5% for both the camera output and the recording.

\_\_\_\_\_ indicates the factory setting.

## SW MODE screen

Item	Display mode	Description of settings
<b>MID GAIN</b> P2 TAPE	(Camera)	Sets the gain value assigned to the M position of the GAIN switch. <b>0dB, 3dB, 6dB, 9dB, 12dB</b>
<b>HIGH GAIN</b> P2 TAPE	(Camera)	Sets the gain value assigned to the H position of the GAIN switch. <b>0dB, 3dB, 6dB, 9dB, 12dB</b>
<b>ATW</b> P2 TAPE	(Camera)	Sets the operation of the ATW (Auto Tracking White Balance) function assigned to the WHITE BAL switch. When the ATW function is set to the AUTO/MANUAL switch or USER button, the operation remains effective. <b>Ach:</b> Activates the ATW function when the WHITE BAL switch is set to A. <b>Bch:</b> Activates the ATW function when the WHITE BAL switch is set to B. <b>PRST:</b> Activates the ATW function when the WHITE BAL switch is set to PRST. <b>OFF:</b> Deactivates the ATW function.
<b>HANDLE ZOOM</b> P2 TAPE	(Camera)	Sets the zoom speed assigned to each setting position of the HANDLE ZOOM switch. <b>L/OFF/H:</b> Sets LOW (low speed)/OFF/HIGH (high speed) to the 1/2/3 position. (Zoom is disabled when set to OFF). <b>L/M/H:</b> Sets LOW (low speed)/MID (medium speed)/HIGH (high speed) to the 1/2/3 position. <b>L/OFF/M:</b> Sets LOW (low speed)/OFF/MID (medium speed) to the 1/2/3 position. (Zoom is disabled when set to OFF).
<b>IRIS DIAL</b> P2 TAPE	(Camera)	Sets the rotation direction and the aperture control of the IRIS dial. (In MANUAL IRIS mode) <b>DOWN OPEN:</b> The iris opens when the IRIS dial is turned downward. <b>UP OPEN:</b> The iris opens when the IRIS dial is turned upward.

\_\_\_ indicates the factory setting.

## Setup menu list (continued)

### SW MODE screen (continued)

Item	Display mode	Description of settings
<b>USER1</b> <b>P2</b> <b>TAPE</b>	<b>(Camera)</b>	Selects the function assigned to the USER1 button. <b>REC CHECK:</b> Performs Rec Check. <b>SPOTLIGHT:</b> Auto iris control for the spotlight ON/OFF <b>BACKLIGHT:</b> Auto iris control for the backlight compensation (Page 39) <b>BLACKFADE:</b> Blackfade (Page 45) <b>WHITEFADE:</b> Whitefade (Page 45) <b>ATW:</b> ATW function ON/OFF <b>ATWLOCK:</b> Fixes the white balance value when the button is pressed during ATW. Press again to perform ATW. <b>GAIN: 18 dB:</b> Press the button to set the gain value to 18 dB. This setting takes effect with the 60i and 60P recording formats only. It is not valid when the recording frame rate is less than 22 fps or when the slow shutter mode (1/15) is established. <ul style="list-style-type: none"> <li>• When the gain value is set to 18 dB or set from 18 dB to another value, the image can be disordered for a moment.</li> <li>• If ON is set for the setting menu AUTO SW and you have selected a setting other than OFF under AGC, auto gain will be provided when auto mode has been established even if GAIN 18dB has been set.</li> </ul> <b>FOCUS RING:</b> Selects the focus ring function (FOCUS or IRIS). The FOCUS RING is functional when the FOCUS switch is in AUTO mode. <b>INDEX/MEMO:</b> Text memo recording (P2 card)(Page 48)/Index recording (cassette tape) (Page 49) <b>SLOT SEL (P2 card only):</b> Selects one of the P2 card slots. (Page 48) <b>SHOT MARK (P2 card only):</b> Shot mark recording (Page 48)
<b>USER2</b> <b>P2</b> <b>TAPE</b>	<b>(Camera)</b>	Selects the function assigned to the USER2 button. The settings are the same as USER1 above. <b>BACKLIGHT</b>
<b>USER3</b> <b>P2</b> <b>TAPE</b>	<b>(Camera)</b>	Selects the function assigned to the USER3 button. The settings are the same as USER1 above. <b>INDEX/MEMO</b>

\_\_\_ indicates the factory setting.



## AUTO SW screen

Item	Display mode	Description of settings
<b>A.IRIS</b> P2 TAPE	(Camera)	<b>ON:</b> Performs the auto iris control in auto mode. The IRIS button is deactivated. <b>OFF:</b> Deactivates the auto iris control in auto mode. This performs the iris control selected with the IRIS button.
<b>AGC</b> P2 TAPE	(Camera)	Sets the Auto Gain Control when the ON is selected in A.IRIS. <b>6dB:</b> Performs the Auto Gain Control (max. 6 dB) in auto mode. <b>12dB:</b> Performs the Auto Gain Control (max. 12 dB) in auto mode. <b>OFF:</b> Does not perform the Auto Gain Control in auto mode. Initiates the control of the gain selected by the GAIN switch.
<b>ATW</b> P2 TAPE	(Camera)	<b>ON:</b> Performs the ATW (Auto Tracing White Balance) function in auto mode. You cannot select ON/OFF of the ATW function with the WHITE BAL switch or the USER button when this is selected. However, if ATWLOCK is assigned to the USER button, you can set the white balance value with the USER button. <b>OFF:</b> Does not perform the white balance function in auto mode. This performs the ATW function selected with the WHITE BAL switch.
<b>AF</b> P2 TAPE	(Camera)	<b>ON:</b> Performs auto focusing in auto mode. You cannot use the FOCUS switch and PUSH AUTO button when this is selected. <b>OFF:</b> Does not perform auto focusing in auto mode. This performs the focusing selected with the FOCUS switch or PUSH AUTO button.

## Setup menu list (continued)

### RECORDING SETUP screen

Item	Display mode	Description of settings
<b>REC FORMAT (P2)</b> P2	(Camera)	Selects the recording format for P2 card. 1080i/60i, 1080i/30P, 1080i/24P, 1080i/24PA, 720P/60P, 720P/30P, 720P/24P, 720P/30PN, 720P/24PN, 480i/60i, 480i/30P, 480i/24P, 480i/24PA
<b>REC FORMAT (TAPE)</b> TAPE	(Camera)	Selects the recording format for cassette tape. 480i/60i, 480i/30P, 480i/24P, 480i/24PA
<b>480i REC MODE</b> P2	(Camera)	Select the recording mode for a 480i recording format. DVCPRO50, DVCPRO, DV
<b>REC FUNCTION</b> P2	(Camera)	Selects the special recording mode. (Pages 47 and 48) NORMAL, INTERVAL, ONE SHOT, LOOP
<b>ONE-SHOT TIME</b> P2	(Camera)	Selects the one-shot recording time. (Page 47) 1F, 2F, 4F, 8F, 16F, 1s
<b>INTERVAL TIME</b> P2	(Camera)	Selects the one-shot interval time. (Page 47) 2F, 4F, 8F, 16F, 1s, 2s, 5s, 10s, 30s, 1m, 5m, 10m
<b>PREREC MODE</b> P2	(Camera)	Sets PRE RECORDING to ON or OFF. (Page 47) ON OFF
<b>REC SPEED</b> TAPE	(Camera) (VCR) (DUB)	Selects the recording time mode. SP: SP (standard) mode LP: LP (long play) mode
<b>AUDIO REC</b> TAPE	(Camera) (VCR)	Selects the audio recording mode for conversion to PCM audio. 32K(12bit): 12bit/32kHz 48K(16bit): 16bit/48kHz
<b>MIC ALC</b> P2 TAPE	(Camera)	Sets mic level auto control to ON or OFF. (Page 53) ON OFF Set to ON to reduce distortion at high input levels. This setting does not change the audio signal recording level. Use the AUDIO control knob to adjust the audio signal recording level.
<b>MIC GAIN 1</b> P2 TAPE	(Camera)	Sets the input level of the external microphone connected to the INPUT 1 terminal. (Page 52) -50dB -60dB
<b>MIC GAIN 2</b> P2 TAPE	(Camera)	Sets the input level of the external microphone connected to the INPUT 2 terminal. (Page 52) -50dB -60dB
<b>25M REC CH SEL</b> P2	(Camera)	Selects the recording audio channel for DVCPRO25 and DV formats. (Page 52) 2CH, 4CH <Notes> <ul style="list-style-type: none"> <li>• Even when 4CH is selected as this item's setting, the signals will be input to two channels (always CH1 and CH2) when there are two 1394 input channels.</li> <li>• Similarly, even when 4CH is selected, the 1394 output signals will be delivered to two channels (always CH1 and CH2).</li> </ul>

\_\_\_\_\_ indicates the factory setting.

## RECORDING SETUP screen (continued)

Item	Display mode	Description of settings
<b>1394 TC REGEN</b> P2 TAPE	(MCR/ VCR)	Selects the time code used for recording the signal from equipment connected to the 1394 terminal. <b>ON:</b> Records using the time code of the signal input through the 1394 terminal. <b>OFF:</b> Records using the time code set in TC MODE/TCG/FIRST REC TC. <ul style="list-style-type: none"> <li>If you select ON here, this has priority over the settings in TC MODE/TCG/FIRST REC TC.</li> <li>If there is no input to the 1394 terminal, the camera follows the settings in TC MODE/TCG/FIRST REC TC.</li> </ul>
<b>TC MODE</b> P2 TAPE	(Camera) (MCR/ VCR) (DUB)	Selects the correction mode of the internal time code generator. <b>DE:</b> Uses the drop frame mode. <b>NDF:</b> Uses the non-drop frame mode. <ul style="list-style-type: none"> <li>The non-drop frame mode will be used when you set recording frame rate of recording format to 24P, 24PA or 24PN.</li> </ul>
<b>TCG</b> P2 TAPE	(Camera) (MCR/ VCR) (DUB)	Sets the mode in which you advance the time code. <b>FREE RUN:</b> The time code is advanced regardless of the operation mode. Records in the dubbing mode in such a way that the time codes of the clips on the P2 card are carried over. User information is also carried over. <b>REC RUN:</b> The time code is advanced only when recording.
<b>FIRST REC TC</b> TAPE	(Camera) (VCR) (DUB)	Selects the time code to be recorded when you start recording. <b>REGEN:</b> Regenerates the time code on the tape to continue recording. <b>PRESET:</b> The time code on the tape is not regenerated. The value you set in TC PRESET is used as the initial value to record the time code. However, if you perform subsequent shooting, the time code will always be regenerated.
<b>TC PRESET</b> P2 TAPE	(Camera) (MCR/ VCR) (DUB)	Sets the initial time code. This is activated when you select PRESET in FIRST REC TC. <ul style="list-style-type: none"> <li>Set the frame value to 0 or a multiple of 5 when you set recording frame rate of recording format to 24P, 24PA or 24PN. If any other value, the recorded time code will mis-match.</li> </ul>

\_\_\_ indicates the factory setting.

## Setup menu list (continued)

### RECORDING SETUP screen (continued)

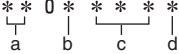
Item	Display mode	Description of settings
<b>1394 UB REGEN</b> <b>P2</b> <b>TAPE</b>	<b>(MCR/ VCR)</b>	Selects the user information used when recording the signals from equipment connected to the 1394 terminal. <b>ON:</b> Records using the user information of the signal input through the 1394 terminal. <b>OFF:</b> Records using the user information set in UB MODE. <ul style="list-style-type: none"> <li>• If you select ON here, this has priority over the setting in UB MODE.</li> <li>• The user information is recorded only when the signal contains the user information.</li> <li>• If there is no input to the 1394 terminal, the camera follows the UB MODE settings.</li> </ul>
<b>UB MODE</b> <b>P2</b> <b>TAPE</b>	<b>(Camera) (MCR/ VCR) (DUB)</b>	Set the content for user information. <b>USER:</b> Records the information of user. <b>TIME:</b> Records the time at recording. <b>DATE:</b> Records the date at recording. <b>TCG:</b> Records the values of the time code generator. <b>FRM. RATE:</b> Records the frame rate information for frame conversion. <div style="text-align: center;">  </div> <ul style="list-style-type: none"> <li><b>a:Checking information for user information</b></li> <li><b>b:Frame sequence No.</b> <ul style="list-style-type: none"> <li>• 0 to 4 are displayed in the 24P/24P (ADV) mode.</li> <li>• F is displayed in the 60i/30P mode.</li> </ul> </li> <li><b>c:Frame rates</b> <ul style="list-style-type: none"> <li>• Frame rate (60/30/24)</li> <li>• I/P ID</li> <li>• Conversion data</li> <li>• Frame rate coefficient</li> </ul> </li> <li><b>d:Recording management data</b> <ul style="list-style-type: none"> <li>• Frame update information</li> <li>• REC START/STOP information</li> </ul> </li> </ul>
<b>UB PRESET</b> <b>P2</b> <b>TAPE</b>	<b>(Camera) (MCR/ VCR) (DUB)</b>	Sets the user information. Select USER in UB MODE.
<b>1394 IN PRESET</b> <b>P2</b> <b>TAPE</b>	<b>(MCR/ VCR)</b>	Synchronizes the internal TCG value with the TC of 1394 input when you press the TC SET button. <b>ON:</b> The synchronization mode is on. <b>OFF:</b> The synchronization mode is off.

\_\_\_ indicates the factory setting.

## PLAYBACK FUNCTIONS screen

Item	Display mode	Description of settings
<b>32K AUDIO</b> <b>TAPE</b>	(VCR)	Sets the audio to output as CH1 and CH2 signals when playing back a tape recorded in the 32K (12bit) audio mode. <b>ST1:</b> Selects the sound that was recorded during shooting. CH1 signals = CH1 track CH2 signals = CH2 track <b>ST2:</b> Selects the sound that was dubbed on the recording. CH1 signals = CH3 track CH2 signals = CH4 track <b>MIX:</b> Mixes the sound that was recorded in shooting and audio dubbing. CH1 signals = CH1 track + CH3 track CH2 signals = CH2 track + CH4 track <b>Note</b> When the sound is recorded in the 48K (16bit) audio mode, CH3 and CH4 do not exist so the following is always the case. CH1 signals = CH1 track CH2 signals = CH2 track
<b>AUDIO OUT (P2)</b> <b>P2</b>	(MCR/ VCR)	Sets the audio signals to output from the AUDIO IN/OUT pin jack when the P2 card or the tape is played back. <b>CH1 · CH2:</b> CH1 output = CH1 signals, CH2 output = CH2 signals <b>CH1:</b> CH1 output = CH1 signals, CH2 output = CH1 signals <b>CH2:</b> CH1 output = CH2 signals, CH2 output = CH2 signals <b>CH3 · CH4: (P2 card only)</b> CH1 output = CH3 signals, CH2 output = CH4 signals <b>CH3: (P2 card only)</b> CH1 output = CH3 signals, CH2 output = CH3 signals <b>CH4: (P2 card only)</b> CH1 output = CH4 signals, CH2 output = CH4 signals
<b>AUDIO OUT (TAPE)</b> <b>TAPE</b>		

\_\_\_ indicates the factory setting.

(continued on the next page)

## Setup menu list (continued)

### PLAYBACK FUNCTIONS screen (continued)

32K AUDIO item/AUDIO OUT item settings and audio track signals output from the AUDIO IN/OUT jack TAPE

Audio recording mode	32K AUDIO setting	AUDIO OUT setting	AUDIO IN/OUT jack CH1 output	AUDIO IN/OUT jack CH2 output
32K (12bit)	ST1	CH1 · CH2 CH1 CH2	CH1 CH1 CH2	CH2 CH1 CH2
	ST2	CH1 · CH2 CH1 CH2	CH3 CH3 CH4	CH4 CH3 CH4
	MIX	—	CH1+CH3	CH2+CH4
48K (16bit)	—	CH1 · CH2 CH1 CH2	CH1 CH1 CH2	CH2 CH1 CH2

## DUBBING SETUP screen

Item	Display mode	Description of settings
<b>FORMAT SEL</b> P2	(DUB)	Selects the format of the clips to be played back during dubbing. <b>1080i/60i, 1080i/30P, 1080i/24P, 1080i/24PA, 720P/60P, 720P/30P, 720P/24P, 720P/30PN, 720P/24PN</b>
<b>PULLDOWN SEL</b> TAPE	(DUB)	Selects the pulldown method for 24PN (native format). <b>24P:</b> The 24 fps images are converted into 60-field interlace signals by the 2:3 conversion system. <b>24PA:</b> The 24 fps images are converted into 60-field interlace signals by the 2:3:3:2 advanced conversion system.
<b>SETUP</b> TAPE	(DUB)	Switch the setup level of video signals in 480i format for dubbing. <b>0%:</b> Setup is switched to 0% for both the camera output and the recording. <b>7.5%:</b> Setup is switched to 7.5% for both the camera output and the recording.

## AV IN/OUT SETUP screen

Item	Display mode	Description of settings
<b>CMPNT OUT SEL</b> P2	(Camera) (MCR)	Selects the type of component terminal. <b>720P:</b> Monitor which supports the D4 terminal <b>1080i:</b> Monitor which supports the D3 terminal <b>480i:</b> Monitor which supports the D1 terminal The signals recorded in the 720P format are cross-converted only when 1080i format signals are to be output. In all other cases, they are output without being converted.
<b>HP MODE</b> P2 TAPE	(Camera)	Selects the sound heard through the headphones. <b>LIVE:</b> The sound which has been input from the microphone is output as is. This setting is selected when delays in the sound are annoying. <b>RECORDING:</b> The sound in the status which is to be recorded (the sound synchronized with the images) is output.
<b>A. DUB INPUT</b> TAPE	(VCR)	Selects the audio to be recorded for audio dubbing. (Page 80) <b>MIC:</b> This sets the input from the internal microphone, INPUT1 and INPUT2 connectors. <b>A. IN:</b> This sets the input from the AUDIO IN/OUT connector.
<b>1394 OUT</b> TAPE	(VCR)	Select ON to convert analog input signals into digital signals and output them from the 1394 terminal. <b>ON OFF</b>

\_\_\_ indicates the factory setting.

## Setup menu list (continued)

### DISPLAY SETUP screen

Item	Display mode	Description of settings
<b>ZEBRA DETECT 1</b> P2 TAPE	(Camera)	Selects the brightness level of the left-leaning zebra patterns on the screen. 50%, 55%, 60%, 65%, 70%, 75%, 80%, 85%, 90%, 95%, 100%, 105%
<b>ZEBRA DETECT 2</b> P2 TAPE	(Camera)	Selects the brightness level of the right-leaning zebra patterns on the screen. 50%, 55%, 60%, 65%, 70%, 75%, 80%, 85%, 90%, 95%, 100%, 105%, OFF <Note> • The zebra patterns do not appear if you select OFF.
<b>MARKER</b> P2 TAPE	(Camera)	Select ON to display the marker. (Page 43) ON OFF • To display the marker, press the ZEBRA button.
<b>SAFETY ZONE</b> P2 TAPE	(Camera)	Sets SAFETY ZONE to ON or OFF. OFF, 90%, 4:3
<b>VIDEO OUT OSD</b> P2 TAPE	(Camera) (MCR/ VCR)	Select ON to output the information displayed on the screen together with the signals from the VIDEO IN/OUT jack. ON OFF <Notes> • When a tape is used for recording, no on-screen displays (OSD) will be output while recording is underway even when this function has been set to ON. However, OSD will be output to the 1394 output during recording standby. If OSD is not required, set the function to OFF. • If this option is set to ON when performing backup recording while a tape is used, the OSD will be output to the 1394 output at all times except when the unit is in the recording mode. Bear in mind that the OSD may be recorded inadvertently if backup recording is performed when a setting other than OFF is selected for the 1394 CONTROL option (page 114) on the OTHER FUNCTIONS screen.
<b>DATE/TIME</b> P2 TAPE	(Camera) (MCR/ VCR)	Sets whether to display the date and time on the screen and whether to output from the VIDEO IN/OUT jack. OFF: The date and time are not displayed. TIME: The time is displayed. DATE: The date is displayed. TIME&DATE: The time and date are displayed. • If you select any setting other than OFF, the date and/or time are included in the output signals regardless of the VIDEO OUT OSD setting. (The OFF setting can be selected also using the remote control. (Page 75))
<b>LEVEL METER</b> P2 TAPE	(Camera) (MCR/ VCR)	Select ON to display the audio level meter. ON OFF

\_\_\_ indicates the factory setting.



## DISPLAY SETUP screen (continued)

Item	Display mode	Description of settings
<b>ZOOM · FOCUS</b> P2 TAPE	(Camera)	Selects the unit of zoom and focus values. <b>OFF, NUMBER, mm/feet, mm/m</b> <Note> Use the mm/feet or mm/m display only as a general guideline since it is not entirely accurate.
<b>CARD/TAPE · BATT</b> P2 TAPE	(Camera) (MCR/ VCR)	Select ON to display the remaining card/tape and battery charge. <b>ON OFF</b>
<b>OTHER DISPLAY</b> P2 TAPE	(Camera) (MCR/ VCR)	Select how much information to display on the screen. (Page 95) <b>OFF, PARTIAL, ALL</b>
<b>CAMERA DATA</b> P2 TAPE	(MCR/ VCR)	Select ON to display the camera settings (such as image stabilizer, F-number, and gain value) during tape playback. <b>ON OFF</b> <Note> In the P2 mode, this item appears only when 480i REC MODE has been set to DV. (Page 106)
<b>LCD BACKLIGHT</b> P2 TAPE	(Camera) (MCR/ VCR)	Adjusts the backlight of the LCD monitor. Select HIGH for brighter backlight. <b>HIGH NORMAL</b>
<b>LCD SET</b> P2 TAPE	(Camera) (MCR/ VCR)	Adjusts the display level of the images on the LCD monitor. (Page 23) <b>LCD COLOR LEVEL</b> <b>LCD BRIGHTNESS</b> <b>LCD CONTRAST</b>
<b>EVF SET</b> P2 TAPE	(Camera) (MCR/ VCR)	Adjusts the display level of the images on the viewfinder. (Page 23) <b>EVF COLOR LEVEL</b> <b>EVF BRIGHTNESS</b> <b>EVF CONTRAST</b>
<b>SELF SHOOT</b> P2 TAPE	(Camera)	Selects the LCD mirror mode for self-portrait shooting. Select MIRROR to reverse left and right at self-portrait shooting. (Page 42) <b>NORMAL MIRROR</b>
<b>EVF MODE</b> P2 TAPE	(Camera) (MCR/ VCR)	Selects the LCD monitor and the viewfinder display setting. <b>ON:</b> Images always appear on the viewfinder. <b>AUTO:</b> Images do not appear on the viewfinder when the LCD is open.
<b>DISPLAY ASPECT</b> P2 TAPE	(Camera) (MCR/ VCR)	Selects the aspect ratio of the LCD monitor and the viewfinder. <b>AUTO:</b> Changes automatically to the appropriate ratio according to the recording or play mode information. <b>4:3</b> : Fixed at 4:3. <Note> Black bands appear at the top and bottom of the screen when images are displayed at a 16:9 aspect ratio. No parts of the images are missing.
<b>EVF COLOR</b> P2 TAPE	(Camera) (MCR/ VCR)	Selects color or black and white images on the viewfinder. <b>ON:</b> Color <b>OFF:</b> Black and white

\_\_\_ indicates the factory setting.

## Setup menu list (continued)

### CARD FUNCTIONS screen

Item	Display mode	Description of settings
<b>SCENE FILE</b> P2	(Camera)	You can save four SCENE FILE settings to the SD memory card, and can also title the saved files. <b>READ:</b> Read <b>WRITE:</b> Write
<b>USER FILE</b> P2	(Camera)	You can save four file settings (excluding SCENE FILE) to the SD memory card, and can also title the saved file. <b>READ:</b> Read <b>WRITE:</b> Write
<b>SD CARD FORMAT</b> P2	(Camera)	Formats the SD memory cards.

### OTHER FUNCTIONS screen

Item	Display mode	Description of settings
<b>REMOTE</b> P2 TAPE	(Camera) (MCR/ VCR)	Sets the operations of the supplied remote control unit. (Remote control setup (Page 19)) <b>VCR1:</b> Accepts commands from the remote control set for VCR1. <b>VCR2:</b> Accepts commands from the remote control set for VCR2. <b>OFF:</b> Operations are not accepted from any remote control.
<b>1394 CONTROL</b> P2 TAPE	(Camera)	Sets the control method for backup recording using a backup unit connected to the 1394 terminal. <b>OFF:</b> The backup unit is not controlled. <b>EXT:</b> The backup unit can be controlled by the START/STOP button. The images shot by the camera recorder are recorded by the backup unit. Note that the camera recorder does not record them. <b>BOTH:</b> The images shot by the camera recorder are recorded by both the camera recorder and backup unit. <b>CHAIN:</b> When the camera recorder's media approaches its end during shooting, the backup unit in the recording stand-by mode automatically starts recording images.
<b>1394 CMD SEL</b> P2 TAPE	(Camera)	Sets how the START/STOP button works for the backup unit. <b>REC P:</b> This switches between recording and pause. <b>STOP:</b> This switches between recording and stop. <b>Note</b> If the backup unit does not have a rec pause function, select STOP.

\_\_\_ indicates the factory setting.

## OTHER FUNCTIONS screen (continued)

Item	Display mode	Description of settings
<b>END SEARCH</b> [TAPE]	(Camera) (VCR)	Sets the operation when the END SEARCH button is pressed. <b>BLANK:</b> Searches for the unrecorded parts on the tape. <b>REC END:</b> Searches for the last segment shot.
<b>PC MODE</b> [P2]	(Camera) (MCR)	Selects the terminal for data transfer. (You cannot select USB and 1394 at the same time.) <b>USB DEVICE:</b> Mode for sending files using the USB connector. <b>1394 DEVICE:</b> Mode for sending files using the 1394 connector. <b>1394 HOST:</b> Mode for copying files from the P2 card onto an external hard disk drive using the 1394 connector.
<b>REC LAMP</b> [P2] [TAPE]	(Camera)	Sets lighting of the tally lamp. <b>OFF:</b> The tally lamp does not light. <b>FRONT:</b> Front tally lamp (microphone side) lights. <b>REAR:</b> Rear tally lamp (viewfinder side) lights. <b>BOTH:</b> Both tally lamps light.
<b>ACCESS LED</b> [P2]	(Camera) (MCR)	Sets the access lamp to ON or OFF. <b>ON:</b> The lamp lights up and blinks as per the regular specifications. <b>OFF:</b> The lamp is OFF in all circumstances.
<b>BEEP SOUND</b> [P2] [TAPE]	(Camera)	Turns the beep sound ON or OFF. <b>ON OFF</b> When ON is selected, the beep is sounded under the circumstances set forth below. When the beep is sounded, the audio signals from the output connector are muted before the beep sound is output. <ul style="list-style-type: none"> <li>• When the memory of the P2 card or the tape has been used up during recording</li> <li>• When a recordable tape has not been loaded when the power is turned on</li> <li>• When a recording-inhibited tape has been inserted</li> <li>• When condensation has formed inside the camera-recorder</li> <li>• When trouble has occurred in the camera-recorder</li> </ul> <Note> When LIVE has been set for the HP MODE option on the AV IN/OUT SETUP screen, no beeping sounds will be emitted even if ON is set for the BEEP SOUND option.
<b>CLOCK SET</b> [P2] [TAPE]	(Camera) (MCR/ VCR)	Sets the camera-recorder's calendar.

\_\_\_ indicates the factory setting.

## Setup menu list (continued)

### OTHER FUNCTIONS screen (continued)

Item	Display mode	Description of settings
<b>TIME ZONE</b> P2 TAPE	(Camera) (MCR/ VCR)	Adds to or deducts from GMT the time value of -12:00 to +13:00 in 30-minute steps. (As an exception, you can set +12:45.) Refer to the table below. <b>0:00</b>

Time difference	Area	Time difference	Area
00:00	Greenwich	- 00:30	
- 01:00	Azores Islands	- 01:30	
- 02:00	Mid-Atlantic	- 02:30	
- 03:00	Buenos Aires	- 03:30	Newfoundland Island
- 04:00	Halifax	- 04:30	
- 05:00	New York	- 05:30	
- 06:00	Chicago	- 06:30	
- 07:00	Denver	- 07:30	
- 08:00	Los Angeles	- 08:30	
- 09:00	Alaska	- 09:30	Marquesas Islands
- 10:00	Hawaii	- 10:30	
- 11:00	Midway Island	- 11:30	
- 12:00	Kwajalein	+ 11:30	Norfolk Island
+ 13:00		+ 10:30	Lord Howe Island
+ 12:00	New Zealand	+ 09:30	Darwin
+ 11:00	Solomon Islands	+ 08:30	
+ 10:00	Guam	+ 07:30	
+ 09:00	Tokyo	+ 06:30	Rangoon
+ 08:00	Beijing	+ 05:30	Bombay
+ 07:00	Bangkok	+ 04:30	Kabul
+ 06:00	Dacca	+ 03:30	Tehran
+ 05:00	Islamabad	+ 02:30	
+ 04:00	Abu Dhabi	+ 01:30	
+ 03:00	Moscow	+ 00:30	
+ 02:00	Eastern Europe	+ 12:45	Chatham Islands
+ 01:00	Central Europe		

\_\_\_ indicates the factory setting.

## OTHER FUNCTIONS screen (continued)

Item	Display mode	Description of settings
<b>POWER SAVE</b> <b>P2</b> <b>TAPE</b>	(Camera)	Selects the power-saving mode when the top panel operation keys, DISP/MODE CHK button, USER1-3 buttons and EVF DTL button have not been operated for 5 minutes or so. <b>ON:</b> The camera-recorder's power is set to OFF. <b>OFF:</b> The cylinder head remains stopped without turning off the camera-recorder's power. <ul style="list-style-type: none"> <li>When connection is made with an external device using the IEEE1394 cable and the communication mode is established in this way, the power will not be set off even when none of the above buttons has been operated.</li> </ul>
<b>LANGUAGE</b> <b>P2</b> <b>TAPE</b>	(Camera) (MCR/ VCR)	Selects the menu language. <b>ENGLISH</b> <b>JAPANESE</b>
<b>USER FILE</b> <b>P2</b> <b>TAPE</b>	(Camera) (MCR/ VCR)	<b>LOAD:</b> The previous scene file settings are loaded. <b>SAVE:</b> The changed user file settings are saved. <b>INITIAL:</b> The user file settings are returned to the factory settings. After performing LOAD or INITIAL, turn the POWER switch OFF and then back ON to activate the settings. <ul style="list-style-type: none"> <li>The setting for the TIME ZONE option (page 114) remains unchanged even when INITIAL is performed.</li> </ul>
<b>HOURLY METER</b> <b>TAPE</b>	(Camera) (VCR)	Displays the total running time (a 5-digit figure per hour) of the cylinder head.

\_\_\_ indicates the factory setting.

## Setup menu list (continued)

### OPTION MENU

This menu is displayed when the DISP/MODE CHK button is held down, and after the details of the shooting status are displayed, the MENU button is then pressed.

Use it to check the connection status during nonlinear editing.

Item	Display mode	Description of settings
<b>1394 STATUS</b> <b>P2</b> <b>TAPE</b>	<b>(Camera)</b> <b>(MCR/</b> <b>VCR)</b>	1394 status display screen appears. <ul style="list-style-type: none"> <li>• When a P2 card is used               <ul style="list-style-type: none"> <li><b>FORMAT:</b> Format of the signals which are input or output.</li> <li><b>RATE:</b> Transfer rate of the signals which are input or output.</li> <li><b>60/50:</b> System of the signals which are input or output.</li> <li><b>CH:</b> Value of the channels in which the signals are input or output.</li> <li><b>SPEED:</b> Transfer speed of the signals which are input or output.</li> <li><b>STATUS:</b> Status of the signals which are input or output using the IEEE1394 digital interface.</li> <li><b>VIDEO:</b> Status of the video signals which are input or output.</li> <li><b>AUDIO:</b> Status of the audio signals which are input or output.</li> </ul> </li> <li>• When a tape is used               <ul style="list-style-type: none"> <li><b>FORMAT:</b> Format of the signals which are input or output.</li> <li><b>RATE:</b> Transfer rate of the signals which are input or output.</li> <li><b>60/50:</b> System of the signals which are input or output.</li> <li><b>CH:</b> Value of the channels in which the signals are input or output.</li> <li><b>SPEED:</b> Transfer speed of the signals which are input or output.</li> <li><b>MODE:</b> Status of the signals which are input or output using the IEEE1394 digital interface.</li> <li><b>RX:</b> Reception status</li> <li><b>TX:</b> Transmission status</li> </ul> </li> </ul>
<b>1394 CONFIG</b> <b>P2</b>	<b>(Camera)</b> <b>(MCR)</b>	1394 extended menus appear. <b>DFLT:</b> Normally, DFLT is used. 1-255

\_\_\_ indicates the factory setting.



## Before calling for service (continued)

### Shooting (when using a P2 card)

<b>Cannot shoot even though the P2 card is inserted correctly.</b>	• The MEDIA switch may be in the TAPE position. If so, set it to the P2 position.	P 25
	• Make sure the P2 card's write-protect switch is not in the PROTECT position. Recording is not possible if it is in this position.	P 26
	• There may be little free memory left on the P2 card. If so, save the data onto another media, and delete the data you no longer need; alternatively, replace the card with a new one.	—
	• The P2 card may be formatted incorrectly. Alternatively, the card you are using may not be formatted for use with the unit. If so, format the card in the unit.	P 27
	• 2GB P2 cards cannot be used.	—

### Shooting (when using a tape)

<b>Cannot record even though the tape is inserted properly.</b>	• The MEDIA switch may be in the P2 position. If this is the case, set it to the TAPE position.	P 29
	• Make sure the VCR lamp is off. You cannot shoot in VCR mode. Press the mode switch to switch to camera mode.	P 29
	• Make sure the tab on the cassette tape for preventing accidental erasure is not set to SAVE. You cannot record when the tab is in this position.	P 31
	• The cassette tape may have reached the end. If so, replace it with another tape.	—
	• Make sure the cassette holder is closed. You cannot operate the camera if the cassette holder is open.	—
	• If the AUTO OFF/T REEL LOCK warning appears, the tape may have snapped. Check the tape.	—

### Editing

<b>Cannot perform audio dubbing.</b>	• Make sure the tab on the cassette tape for preventing accidental erasure is not set to SAVE. You cannot edit when the tab is in this position.	P 31
	• You may be trying to edit a part that was shot in LP mode. You cannot dub after recording in LP mode as the track on the tape is thinner than the head.	—
<b>Cannot read the data on the SD memory card.</b>	• Make sure the SD memory card is formatted correctly. If it is not, format the card in the unit.	P 32
	• In the tape mode, SD memory cards cannot be read. Switch to the P2 mode in order to read these cards.	P 32
<b>Cannot perform nonlinear editing.</b>	• Check the specifications of your computer and connecting cable.	P 82
<b>Cannot dub onto an external device.</b>	• Make sure the external device is connected correctly.	P 78, 79



## Displays

<b>Something is wrong with the time code display.</b>	<ul style="list-style-type: none"> <li>The time code display may not register a regular count if a tape is played in the reverse slow mode. This is normal.</li> </ul>	—
<b>The remaining tape display differs from the actual amount of tape remaining.</b>	<ul style="list-style-type: none"> <li>The remaining tape is not displayed accurately if you shoot continuously for periods of less than 30 seconds.</li> <li>The display may show 2 to 3 minutes less than the actual time remaining on the tape.</li> </ul>	—

## Playback

<b>Cannot play even when I press the play button.</b>	<ul style="list-style-type: none"> <li>Make sure the MCR/VCR lamp is on (press the mode button). No kind of playback operation can be performed unless this lamp is on.</li> </ul>	P 62, 63
<b>Cannot play back P2 cards or tapes.</b>	<ul style="list-style-type: none"> <li>Make sure the MEDIA switch is in the correct position. If not, set it to the P2 or TAPE position.</li> </ul>	P 62, 63
<b>Mosaic-like noise appears when I cue or review a tape.</b>	<ul style="list-style-type: none"> <li>This noise is inherent to digital video technology. This is normal.</li> </ul>	—
<b>Images do not appear on the television even though I have connected the camera-recorder properly.</b>	<ul style="list-style-type: none"> <li>Make sure the input selector on your television is set to video input. Read the television's instructions carefully and select the correct video input connector for the camera-recorder.</li> <li>When a component video cable is connected, video signals are not output from the VIDEO OUT and S-VIDEO OUT connectors.</li> </ul>	— P 79
<b>The playback images are not displayed clearly.</b>	<ul style="list-style-type: none"> <li>The camera-recorder's heads may be dirty. Images will not be displayed clearly if the heads are dirty.</li> </ul>	—
<b>Cannot hear any sound from the camera-recorder's speaker.</b>	<ul style="list-style-type: none"> <li>You may have turned down the camera-recorder's volume control too far. Adjust the volume level using the AUDIO MON/ VAR button+.</li> </ul>	P 75
<b>I can hear two sets of sound.</b>	<ul style="list-style-type: none"> <li>You may have selected "MIX" as the 32K AUDIO setting in the PLAYBACK FUNCTION screen.</li> <li>If you perform audio dubbing on a tape that was recorded with 32K (12bit) selected as the AUDIO REC setting in the RECORDING SETUP screen, you will hear the sound heard during recording and that of the audio dubbing. You can also listen to each sound separately.</li> </ul>	P 109 P 106
<b>When I performed audio dubbing, the original sound was erased.</b>	<ul style="list-style-type: none"> <li>If you perform audio dubbing on a tape that was recorded with 32K (12bit) selected as the AUDIO REC setting in the RECORDING SETUP screen, you will hear the sound heard during recording and that of the audio dubbing. To leave the original sound intact, make sure that 32K (12bit) is selected when you shoot.</li> </ul>	P 106
<b>Cannot perform hot swap playback.</b>	<ul style="list-style-type: none"> <li>This unit does not support hot swap playback. To replace one card with another during dubbing, stop the dubbing first, and upon completing the replacement, resume it.</li> </ul>	P 87

## Before calling for service (continued)

### Other

<p><b>Cannot remove the tape.</b></p>	<ul style="list-style-type: none"> <li>• Make sure the camera is supplied with power. Make sure the AC adapter or battery is inserted correctly. As long as the power is supplied, you can remove the tape without turning ON the POWER switch.</li> </ul>	<p>P 17</p>
<p><b>Cannot perform any operation other than removing the tape.</b></p>	<ul style="list-style-type: none"> <li>• Condensation may have formed. If this happens, the only operation that you will be able to perform is to remove the tape. Wait until the condensation has dried out.</li> <li>• When the cassette holder is closed immediately after sliding EJECT switch to open the cassette holder, sometimes operations other than eject cannot be performed. In this case, slide EJECT switch again to open the cassette holder, check that the cassette mechanism has completed ejecting operation, and then close the cassette holder.</li> </ul>	<p>P 125 —</p>
<p><b>The remote control does not work.</b></p>	<ul style="list-style-type: none"> <li>• The button battery in the remote control may have run out. If the remote control fails to work even if it is operated close to the remote control sensor of the camera-recorder, it means that the button battery has run out. Replace it with new one.</li> <li>• Make sure the remote control setting is the same for the remote control unit and the camera-recorder. If the REMOTE setting is different on the remote control and the camera-recorder, the remote control will not work.</li> </ul>	<p>P19 P19</p>
<p><b>There is a rattling sound when the camera-recorder is tilted back and forth.</b></p>	<ul style="list-style-type: none"> <li>• There are some parts of the camera that make a rattling sound in the VCR mode or when the POWER switch is OFF. This is normal.</li> </ul>	<p>—</p>
<p><b>A clicking sound is heard when the power is turned on or when the MCR/VCR mode is switched to the camera mode.</b></p>	<ul style="list-style-type: none"> <li>• This initialization operation is performed when the camera starts up. It occurs due to the construction of the camera and is not indicative of any trouble.</li> </ul>	<p>—</p>

# Operating precautions

---

## **Do not allow any water to get into the camera-recorder when using it in the rain or snow or at the beach.**

- Failure to heed this caution will cause the camera-recorder, P2 card or cassette to malfunction (and may result in irreparable damage).

## **Keep the camera-recorder away from equipment (such as TV sets and video game machines) that generate magnetic fields.**

- Using the camera-recorder on top of or near a TV set may cause distortion in the images and/or sound due to the electromagnetic waves that the set emits.
- The powerful magnetic fields generated by speakers or large motors may damage your recordings or distort the images.
- The electromagnetic waves emitted from a microcomputer will adversely affect the camera-recorder, causing the images and/or sound to be distorted.
- If the camera-recorder is so adversely affected by products that generate magnetic fields that it no longer operates properly, turn it off and remove the battery or unplug the AC adapter from the power outlet. Then install the battery again or reconnect the AC adapter. After this, turn the camera-recorder back on.

## **Do not use the camera-recorder near radio transmitters or high-voltage equipment.**

- Using the camera-recorder near a radio transmitter or high-voltage equipment may adversely affect the recorded images and/or sound.

## **Do not allow any sand or dust to get into the camera-recorder when using it at the beach and other similar places.**

- Sand and dust can damage the camera-recorder, P2 card and cassette. (Be especially careful when inserting or removing the P2 card or cassettes.)

## **AC adapter and battery**

- If the battery is extremely hot or cold, the CHARGE lamp will blink several times before charging starts.
- If the CHARGE lamp continues to blink even when the battery temperature is normal, there may be something wrong with the battery or AC adapter. Contact your dealer.
- The battery takes longer to charge when it is warm.
- The AC adapter can interfere with radio reception so keep radios at least 1 meter away from it.
- The AC adapter may make some noise when you are using it, but this is normal.

## **Take precautions not to drop the camera when moving it.**

- Strong impacts may damage the camera and cause it to stop working.
- Handle the camera with care, using the hand strap or shoulder strap to carry it.

## **Do not spray the camera with insect sprays or other volatile substances.**

- These can warp the camera or cause the finish to come off.
- Do not leave the camera-recorder in contact with rubber or PVC products for extended periods of time.

## **After use, remove the cassette and battery and disconnect the AC power supply cord.**

- The tape can become slack or damaged if you leave it in the camera.

## Operating precautions (continued)

---

### Battery characteristics

This camera-recorder uses a rechargeable lithiumion battery that uses its internal chemical reaction to generate electrical energy. This reaction is easily influenced by the ambient temperature and humidity, and the battery's effective operating time is reduced as the temperature rises or falls. In very low temperatures, the battery may last only 5 minutes.

Protective circuitry functions if you use the battery where it is very hot and you will have to wait before you can use it again.

### Remove the battery after use

Completely remove the battery. (The battery continues to be used even if you have turned the camera off.) The battery can over discharge if you leave it in the camera and it may become impossible to recharge it.

### Disposing of spent batteries

The battery will become unchargeable. Rather than throwing the battery into the garbage, take it to a store that can assist in recycling it.

### What to remember when throwing memory cards away or transferring them to others

Formatting memory cards or deleting data using the functions of the unit or a computer will merely change the file management information: it will not completely erase the data on the cards. When throwing these cards away or transferring them to others, either physically destroy them or use a data deletion program for computers (commercially available) to completely erase the data. Users are responsible for managing the data on their memory cards.

### Liquid crystal displays

- Images or letters can get burned onto the screen of the LCD or viewfinder if they are displayed for a long time, but you can fix this by leaving the camera off for several hours.
- The liquid crystal parts are highly precise with 99.99% of the pixels effective. This leaves less than 0.01% of pixels that may not light or may remain on all the time. These phenomena are normal and will have no effect on the images you shoot.
- Condensation may form if you use the camera where temperatures fluctuate. Wipe dry with a soft, dry cloth.
- The LCD may appear dim after immediately turning on a cold camera, but will brighten as the camera warms up.

### Do not point the lens or viewfinder at the sun.

Doing so may damage the parts inside.

### Protective caps for the connectors

Keep the protective caps fitted over any connectors that are not being used.

# Updating the driver in the camera

---

For the latest information on drivers, visit the P2 Support Desk at the following Web sites.

<https://eww.pavc.panasonic.co.jp/pro-av/>

To update a driver, select PROPERTY on the thumbnail menu and then SYSTEMINFO to check the camera-recorder's version, go to the site given above, and download the driver as necessary.

The updating procedure is completed when the downloaded file has been loaded into the camera-recorder via the SD memory card. For further details on this procedure, go the site given above.



- For installation, you must connect the AC adapter.
- If you are going to use SD memory cards with this camera-recorder, use only cards which are in compliance with the SD standard.

Always format SD memory cards on this camera-recorder. If it is necessary to format them on a personal computer, download the special software program from the site given above before using them.

## Condensation

---

### How to find out if there is condensation inside and what to do about it

If the condensation mark  blinks, condensation has formed inside the camera-recorder. If this happens, the power automatically turns off in few seconds. Even if the condensation mark  is displayed, the camera-recorder will operate if set to P2 mode. If the camera-recorder is switched back to tape mode, the condensation mark  is displayed again, and the power automatically turns off in a few seconds.

Take the following action.

(1) Remove the cassette

No other functions will be possible. It may not even be possible to remove the cassette tape depending on the amount of condensation. If this is the case, wait two to three hours before removing the cassette.

(2) Wait two to three hours with the cassette holder open.

The time you need to wait depends on the amount of condensation and the ambient temperature.

(3) Turn on the power two to three hours later and check whether or not the condensation display has gone off.

To make doubly sure, wait another hour or so after the condensation display has gone off before using the camera-recorder again.

### Also remember that even when the condensation display has not appeared, condensation may be forming.

- Condensation builds up gradually so the condensation display may not appear for 10 to 15 minutes after it has started to form inside. In very cold areas, the condensation may freeze. If this happens, it will take another two to three hours for it to thaw out.

# System resetting

Reset the system microcomputer if you can no longer operate the camera-recorder even though its power is on or a similar kind of a problem has occurred.

Use a pointed object to press the RESET button on the camera-recorder.

The menu setting entered and memory contents will not be cleared even when the system is reset.

RESET button

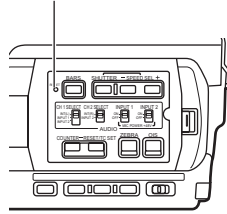

---

Do not press the RESET button when the camera-recorder is operating normally.

---

# Cleaning

**When cleaning, do not use benzene or thinner.**

- Using benzene or paint thinners may deform the camera-recorder and/or cause the surface finish to peel off.
- Before proceeding with maintenance, remove the battery or disconnect the AC cord from the power outlet.
- Use a soft, clean cloth to wipe the camera-recorder. To remove stubborn dirt, wipe the camera-recorder with a cloth moistened with kitchen detergent that has been diluted with water and then use a dry cloth to take up the remaining moisture.

## Cleaning the Viewfinder

If there is dust inside the view finder, remove the eye cup holder and get rid of the dust.

- The interior of the eye cup holder is specially finished, so do not ever wipe it. If there is dust on it, blow it off with an air blower.
- Remove the eye cup holder with the eye cup attached by rotating it counterclockwise. (It will be tightly screwed on.) When you do this, tilt the view finder slightly upward.
- To amount the eye cup holder, align the ridges and grooves of the eye cup holder and camera-recorder, and turn clockwise until the holder clicks into place.

Eye cup holder

Eye cup

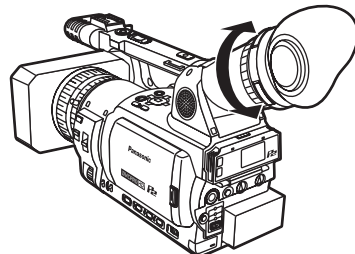
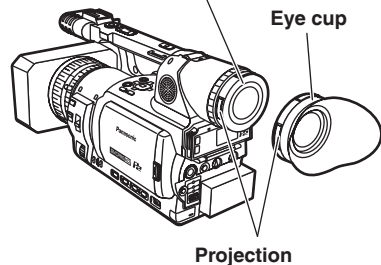

# Video Heads

---

Dirty video heads cause partial mosaic-pattern noise or make the whole display bluish on playback.

When the video heads get extremely dirty, the recording quality decreases, and, in the worst case, it won't record at all.

## Causes of dirty video heads

- Dusty atmosphere
- High temperature and humidity
- Scratches on tapes
- Overuse

## Using A Cleaning Tape (Page 132, OPTIONAL UNITS)

- (1) Insert the cleaning tape in the camera recorder and turn on the power switch
- (2) Press the mode button and make sure the VCR lamp is on.
- (3) Press the operation button ►. Press ■ within ten seconds.  
(Do not rewind the tape at this point.)
- (4) Eject the cleaning tape and insert another tape. Record on it and play it back. Make sure the picture is fine.
- (5) If the picture is not clear, repeat the steps 1-4.  
(Do not use the cleaning tape more than four times in a row.)

- Do not rewind the cleaning tape until it gets to the end of the tape. When the tape gets to the end, rewind it to the beginning to use it again.
- If the video head gets dirty soon after you clean it, the cleaning tape might be damaged. Stop using the cleaning tape right away.
- Overusing the cleaning tape might damage the video head. If the video head is damaged, the picture quality will not improve even when you clean the video head.
- When you can't clean a dirty video head with the cleaning tape, it needs cleaning and repair at the dealer. Please contact them.

## Regular Maintenance

For the superior picture quality, we recommend replacing consumable parts such as a video head approximately every 2,000 hours of use. (However, this estimated time varies greatly depending on the environment in which it is used, such as temperature, humidity, and dust.)

# Storage Precautions

---

Before storing the video camera, remove both the cassette and battery.

Store all of these items in a place with low humidity and relatively constant temperature.

[Recommended temperature range: 15°C to 25°C (59 °F to 77 °F )]

[Recommended relative humidity: 40% to 60%]

## Video camera

- Wrap the video camera in a soft cloth to keep the dust off.

## Battery

- The battery life is shortened in places with extreme temperatures.
- Storing the battery in a location with oily vapors or high dust concentrations may corrode the terminals or cause other damage, leading to malfunction.
- **Keep metal objects (such as necklaces and hair pins) away from the terminals. Shortcircuiting may occur across the terminals, causing the battery to heat up, and you may seriously burn yourself if you touch the battery in this state.**
- Discharge the battery before storing it. When storing it for an extended time, charge it at least once a year, use up its charge in the camera-recorder, and then store it again.

## P2 cards

- After ejecting a P2 card from the unit, be absolutely sure to attach its special cap to keep sand and dust away from the connector area. Stow the P2 cards in their own cases when storing them or carrying them around.
- Do not leave P2 cards in areas where corrosive gases, etc. are present.

## Cassette Tapes

- Do not store in locations exposed to high temperatures. This could damage the tape so that mosaic-shaped noise occurs during playback.
- Always rewind your tapes to the beginning before storing them. They will become slack if left stopped part way through for six months or more (the time frame depends on the storage conditions). Make sure that all of your tapes are rewound to the beginning before storage.
- Always put your tapes back into their original cases before storing them. Dust, direct sunlight (ultraviolet rays) or humidity may damage the tapes. Dust contains particles of hard minerals. These particles could burrow into the cassettes, causing damage to the video camera's heads or other parts. Make sure that all of your tapes are stored in the cases.
- Fast forward and rewind tapes once every six months. If tapes are left wound up for more than a year, the expansion and contraction caused by changes in temperature and humidity may distort the tapes or make them stick to each other.
- Do not place substances or equipment with strong magnetic fields near cassettes.
- Tapes are surfaced with microscopically small magnetic particles where the signals are recorded. Magnetic necklaces, toys and other products may have an unexpectedly strong magnetic field and this may cause data loss or generate noise on the screen and in the sound.

## SD memory cards

- After ejecting an SD memory card from the unit, be absolutely sure to stow it in its own case.
- Do not leave SD memory cards in areas where corrosive gases, etc. are present.
- Do not leave the cards inside vehicles, in places exposed to direct sunlight or in other places where the temperature is high.
- Do not leave the cards where the humidity level is high or where there are high concentrations of dust.



# Recording format

				Frame rate			
				60	30P	24P	24PA
Video format	P2 Card	DVCPRO HD	1080i/60i	1080i/60i	1080i/30P over 60i	1080i/24P over 60i	1080i/24PA over 60i
			720P/60P	720P/60P	720P/30P over 60P	720P/24P over 60P	—
			720P/30PN	720P/60P native recording	720P/30PN	720P/24P native recording	—
			720P/24PN	720P/60P native recording	720P/30P native recording	720P/24PN	—
		DVCPRO50 DVCPRO DV	480i/60i	480i/60i	480i/30P over 60i	480i/24P over 60i	480i/24PA over 60i
	Tape	DV					

				Frame rate						
				12	18	20	22	26	32	36
Video format	P2 Card	DVCPRO HD	1080i/60i	—						
			720P/60P	720P/12P - 48P over 60P						
			720P/30PN	720P/12P - 48P native recording						
			720P/24PN	720P/12P - 48P native recording						
		DVCPRO50 DVCPRO DV	480i/60i	—						
	Tape	DV								

# Specifications

---

## [GENERAL]

Supply voltage: DC7.2 V/7.9 V Power consumption 11.6 W (when the viewfinder is used) 12.0 W (when the LCD monitor is used) 14.0 W (max.)
--

 indicates safety information.

### Ambient operating temperature

0 °C to 40 °C (32 °F to 104 °F)

### Ambient operating humidity

10% to 85% (no condensation)

### Weight

2.5 kg (5.5 lb)  
(excluding battery and accessories)

### Dimensions (W x H x D)

168.5 mm x 180.0 mm x 390.0 mm  
(6-5/8 inches x 7-1/16 inches x 15-3/8 inches)

## [Camera]

### Pickup devices

CCD image sensor (x3)  
(1/3-inch, interline transfer, progressive-capable)

### Lens

LEICA DICOMAR Optical image stabilizer lens,  
Motorized/Manual selectable 13x zoom,  
F1.6 (f = 4.2 mm to 55 mm)  
(35 mm equivalent: 32.5 mm to 423 mm)

### Color separation optical system

Prism system

### ND filter

1/8, 1/64

### Gain settings

0/+3/+6/+9/+12/+18 dB (60i/60P mode)  
0/+3/+6/+9/+12 dB (30P/30PN/24P/24PA/24PN)

### Shutter speed settings

Regular shutter speed

60i/60P mode:

1/60 (OFF), 1/100, 1/120,  
1/250, 1/500, 1/1000, 1/2000 sec.

30P/30PN mode:

1/30, 1/50 (OFF), 1/60, 1/120, 1/250,  
1/500, 1/1000 sec.

24P/24PA/24PN mode:

1/24, 1/50 (OFF), 1/60, 1/120, 1/250,  
1/500, 1/1000 sec.

Synchronous scan settings

60i/60P mode: 1/60.0 sec. to 1/249.8 sec.  
30P/30PN mode: 1/30.0 sec. to 1/249.8 sec.  
24P/24PA/24PN mode:

1/24.0 sec. to 1/249.8 sec.

Shutter opening angle

Can be set in 0.5° steps from 10° to 350°  
(When FILM CAM is set for OPERATION  
TYPE under SCENE FILE screen)

Slow shutter speed settings

60i/60P mode: 1/15, 1/30

30P/30PN mode: 1/15

### Minimum subject luminance

3 lx (F1.6, gain +12 dB with a shutter speed of  
1/24)

### Lens hood

Large-sized lens hood with wide angle of view

### Filter diameter

82 mm

## [VIDEO P2] (DVCPRO HD 1080i 720P)

### Sampling frequency

Y: 74.25 MHz, Pb/Pb: 37.125 MHz

### Quantizing

8 bit

### Video compression system

DCT + variable-length code

### Video compression rate

1/6.7

### Video recording bit rate

100 Mbps

## Specifications (continued)

### [AUDIO P2] (DVCPRO HD 1080i 720P)

#### Sampling frequency

48 kHz

#### Quantizing

16 bit/4 CH

#### Frequency response

20 Hz to 20 kHz

#### Wow & flutter

Below measurable limits

### [MEMORY CARD]

#### Video recording formats:

DVCPRO HD

1080i/60i (30P over 60i, 24P over 60i, 24PA over 60i)

720P/60P (30P over 60P, 24P over 60P)

720P/30PN

720P/24PN

DVCPRO50/DVCPRO/DV

480i/60i (30P over 60i, 24P over 60i, 24PA over 60i)

#### Audio recording formats:

PCM digital recording

48 kHz 16-bit 4CH (DVCPRO HD/DVCPRO50)

48 kHz 16-bit 2CH/4CH selectable (DVCPRO/DV)

#### Recording/playback time:

Approx. 4 minutes

When recorded in DVCPRO HD format using one AJ-P2C004HG card with audio signals recorded on 4 channels.

Approx. 8 minutes

When recorded in DVCPRO HD format using one AJ-P2C008HG card with audio signals recorded on 4 channels.

<Note>

- This recording time represents one shot continuously recorded on a P2 card. The recording time may be shorter, depending on the number of shots recorded.
- The 720P/30PN and 720P/24PN formats are not included in the DVCPRO HD recording format.

### [TAPE]

#### Recording format

DV (Digital video SD format)

#### Tape format

Mini DV system

#### Video signals recorded

480i/60i (NTSC)

In progressive mode (30P/24P/24PA), convert to 480i/60i and record.

#### Frame rate

60i (480i), 24P, 24PA, 30P

#### Audio signals recorded

PCM digital recording

16bit: 48kHz/2CH

12bit: 32kHz/4CH

#### Recording tracks

Digital video/audio:

Helical tracks

Time code:

Helical tracks (sub code area)

#### Tape speeds

SP mode: 18.812 mm/sec.

LP mode: 12.555 mm/sec.

#### Recording time (when AY-DVM63 is used)

SP mode: 60 minutes

LP mode: 90 minutes

#### Tapes used

6.35 mm wide metal tapes

#### FF/REW time

Approx. 140 sec. (when AY-DVM63 is used)

### [VIDEO IN/OUT]

#### Analog component output

720P, 1080i, 480i format monitors supported

Y: 1.0 V [p-p], 75  $\Omega$

P<sub>B</sub>/P<sub>R</sub>: 0.7 V [p-p], 75  $\Omega$

#### Analog composite input/output (automatic input/output switching)

Pin jack x 1, 1.0 V [p-p], 75  $\Omega$

#### S-VIDEO IN/OUT (automatic input/output switching)

4 pins x 1, Y/C separate signal

Y: 1.0 V [p-p] 75  $\Omega$ , C: 0.286 V [p-p], 75  $\Omega$

---

**[AUDIO IN/OUT]****XLR input**

XLR (3 pins) x 2 (INPUT 1, INPUT 2),  
LINE/MIC selectable, high impedance  
LINE: 0 dBu  
MIC: -50 dBu/-60 dBu (selectable in menu)

**LINE IN/OUT (automatic input/output switching)**

Pin jack x 2 (CH1, CH2)  
Input: 316 mV, high impedance  
Output: 316 mV, 600 Ω

**Internal microphone**

Stereo microphone

**PHONES**

3.5-mm stereo mini jack

**Internal speaker**

28 mm diameter x 1

**[OTHER INPUTS/OUTPUTS]****Digital interface**

4 pins, digital input/output, compliant with IEEE  
1394 standard

**USB**

Type mini B connector (compliant with USB ver.  
2.0)

**CAM REMOTE**

Mini jack (3.5 mm diameter)  
(FOCUS, IRIS)  
Super mini jack (2.5 mm diameter)  
(ZOOM S/S)

**DC INPUT**

2P x 1, DC 7.9 V

**[Monitor]****LCD monitor**

3.5-inch LCD color monitor, 210,000 pixels

**Viewfinder**

0.44-inch LCD color viewfinder, 235,000 pixels

**[AC ADAPTER]**

Power Source: 100-240 V AC, 50/60 Hz 24 W Power Output: 7.9 V DC, 1.9 A (Video Camera) 8.4 V DC, 1.2 A (Charge)
---

indicates safety information.

**Weight**

160 g (0.35 lb)

**Dimensions (W x H x D)**

70 mm x 44.5 mm x 116 mm  
(2-3/4 inches x 1-3/4 inches x 4-9/16 inches)

**[OPTIONAL UNITS]****XLR microphone**

AG-MC100G

**Battery**

CGP-D28 (2800 mAh)  
CGA-D54 (5400 mAh: equivalent to accessory  
battery)

**Cleaning tape**

AY-DVMCL

Weight and dimensions when shown are  
approximately.  
Specifications are subject to change without notice.



## Information on Disposal in other Countries outside the European Union



This symbol is only valid in the European Union.  
If you wish to discard this product, please contact your local authorities or dealer and ask for the correct method of disposal.



# Panasonic<sup>®</sup>

**PANASONIC BROADCAST & TELEVISION SYSTEMS COMPANY**  
UNIT COMPANY OF PANASONIC CORPORATION OF NORTH AMERICA

**Executive Office:**

One Panasonic Way 4E-7, Secaucus, NJ 07094 (201) 348-7000

**EASTERN ZONE:**

One Panasonic Way 4E-7, Secaucus, NJ 07094 (201) 348-7621

**Southeast Region:**

1225 Northbrook Parkway, Ste 1-160, Suwanee, GA 30024 (770) 338-6835

**Central Region:**

1707 N Randall Road E1-C-1, Elgin, IL 60123 (847) 468-5200

**WESTERN ZONE:**

3330 Cahuenga Blvd W., Los Angeles, CA 90068 (323) 436-3500

**Government Marketing Department:**

52 West Gude Drive, Rockville, MD 20850 (301) 738-3840

**Broadcast PARTS INFORMATION & ORDERING:**

9:00 a.m. – 5:00 p.m. (EST) (800) 334-4881/24 Hr. Fax (800) 334-4880

Emergency after hour parts orders (800) 334-4881

**TECHNICAL SUPPORT:**

Emergency 24 Hour Service (800) 222-0741

**Panasonic Canada Inc.**

5770 Ambler Drive, Mississauga, Ontario L4W 2T3 (905) 624-5010

**Panasonic de Mexico S.A. de C.V.**

Av angel Urraza Num. 1209 Col. de Valle 03100 Mexico, D.F. (52) 1 951 2127

**Panasonic Puerto Rico Inc.**

San Gabriel Industrial Park, 65th Infantry Ave., Km. 9.5, Carolina, Puerto Rico 00630 (787) 750-4300

